

PHASOR Measurement Unit

P.I.D

Fractional Order

C o n t r o l



Process

Identification

-using ANN

M.I.M.O

Interaction

C o n t r o l

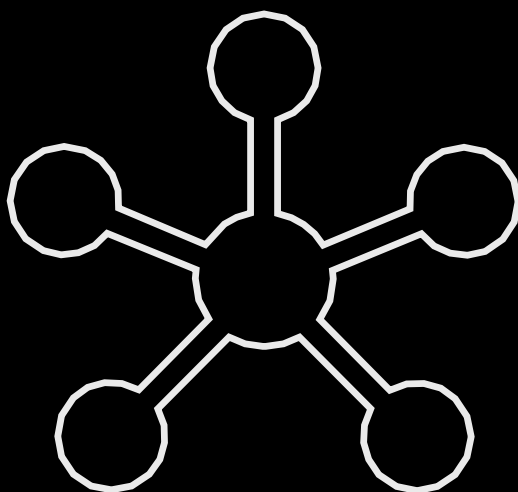

Power System

State Estimation

Volume 1 • September 2018

<http://ece.iiitdmj.ac.in/pdf/pac/PacMag.pdf>

features

- | | | | |
|----|---|----|---|
| 6 | Multi-Input Multi-Output Processes: Design and Challenges
<i>By- Bharat Verma</i> | 23 | Online monitoring of Power System through Phasor Measurement Unit
<i>By- Preeti Jain</i> |
| 10 | Review of power system state estimation techniques
<i>By- Abhishek Sharma</i> | 28 | On Fractional Order $PI^{\lambda}D^{\mu}$ Controllers
<i>By- Rishika Trivedi</i> |
| 17 | Identification and Modelling of systems using Artificial Neural Networks
<i>By- Sudeep Sharma</i> | 32 | FUZZY LOGIC: An Ultimate Control Approach
<i>By- Roshan Bharti</i> |
| 20 | Overview of Non-Intrusive Load Monitoring
<i>By- Vijay Rathore</i> | | |



www.extremetech.com/extreme/215170-artificial-neural-networks-are-changing-the-world-what-are-they

<https://ocw.mit.edu/courses/electrical-engineering-and-computer-science/6-061-introduction-to-electric-power-systems-spring-2011/>



Columns & departments

- | | | | |
|---|--|----|--|
| 2 | From the Director | 36 | Alumnae speaks |
| 3 | From the Head of ECE Department | 37 | Editorial Board |
| 4 | From the Editor | 42 | From the Secretaries of Associate Editors |
| 5 | From the Desk of Editor | | |

Contents

From the Director

Prof. SG Deshmukh
Officiating Director
PDPM-IIITDM, Jabalpur-482005.



Dear Reader
Season's Greetings!

The publication of PacMag 2018 has given new wings to the technical aspects of the PDPM-IIITDM Jabalpur as it is the first ever technical magazine. It is a new milestone in the history of the institute.

I am sure the magazine will maintain its continuity and periodicity. The efforts of entire team are reflected in PacMag 2018 by various review articles. The team has done a commendable job in professional manner. This deserve a rich appreciation from all quarters.

The adorable feature of the magazine is its diversity in the article's topic, breadth and depth. I understand that the magazine is going to be multidisciplinary in near future. In this world of growing technology, research is ever evolving which has been taken care in this issue. The latest topics of research are well articulated. This will enable the upcoming researchers to define their problem statement accurately and precisely.

I hereby take the opportunity to thank the entire team for successful publication of this issue of technical magazine PacMag 2018 and hope that the later editions will prove to be value-additions to the knowledge depository of the institute.

Wish you all happy reading!

SG Deshmukh
Officiating Director

From the Head of ECE Department

Dr. Dinesh Kumar Vishwakarma
Associate Professor
ECE Department
PDPM-IIITDM, Jabalpur-482005.



I sincerely appreciate the efforts of Power and Control group from ECE in launching the new Magazine PacMag, it will serve truly a broader perspective in connecting people within and across the Institute working in this important domain.

The success of any Magazine is directly proportional to the sincerely, hard work and dedication and I am sure the group will maintain the quality and sanctity. I will also recommend using the online networking resources to give a kick start to this magazine and make people aware of it's existence.

I wish good luck to the editorial board to maintain the continuity of the publication of PacMag in near future. I hereby extend all the support available in the capacity of the head of the Department, needed for this magazine.

Again, All the best for the launch and keep up the good work.

Dr. Dinesh Kumar Vishwakarma

From the Editor

Dr. Prabin Kumar Padhy
Associate Professor
ECE Department
PDPM-IIITDM, Jabalpur-482005.



Welcome to the first issue of the PacMag. 26th January 2018 has witnessed the launch of the magazine cover. This magazine focuses on future opportunities and exemplifies the accomplishments of power & control technology. This magazine is launched to set a milestone in power & control systems research. The content of the magazine contends vehemently for the importance of power & control in society. This magazine is a venture which may turn out to be worth to the students, faculty and decision makers in academia.

In these challenging times of rapid technology developments, the research communities needs to reinvent itself and make a compelling case to justify investment. In addition, by highlighting the impact of power & control on society, this magazine will be instrumental for outreach to the broader public. The Impact of Power & Control Technology articulates the value of power & control, for today and for the future. In this regard, the magazine is a contribution towards the respective fields, and we hope it will serve as a foundation for further such efforts as well.

Dr. Prabin Kumar Padhy

From the desk of Editor

Dr. Sachin Kumar Jain
Assistant Professor
ECE Department
PDPM-IIITDM, Jabalpur-482005.



I am happy to see that our students of Power & Control lab have taken up a novel and constructive initiative to share their research work with entire IIITDMJ community in the form of this e-magazine, that will not only allow them to develop writing skills but also make their minds independent from the clutches of regular syllabus-oriented learning and provides a platform for developing managerial and editorial skills. This first issue is dedicated for introduction of various research problems on which our students are working at present. Hence, this will ignite the innovative incoming students to explore upcoming research directions in power & control and come up with feasible and affordable solutions of the emerging research challenges for the benefit of the society.

This is just the beginning, and younger students must carry on with continuous improvement to take this magazine to the new heights of success and popularity; ... beyond the institute, ... beyond the state, and beyond the nation, at international level of benchmark. Feedback and their implementation will be a key for this.

Wishing all the best for bright future,

Dr. Sachin Kumar Jain

Multi-Input Multi-Output Processes: Design and Challenges

Bharat Verma
ECE Department
PDPM-IIITDM, Jabalpur-482005.

Abstract: Controlling of Multi-Input Multi-Output processes (MIMO) are more challenging than the Single-Input Single-Output processes (SISO) due to the loop-interaction. The theory of loop interaction and its measurement method are discussed in this paper.

Keywords: MIMO Process, Relative Gain Array, Interaction Measurement, Centralised Control.

1 INTRODUCTION

There are three primary objectives for any controller design, i.e., minimum Settling time, minimum overshoot and Robustness. In addition to this, the interaction among the loops is an additional challenge in Multi-Input-Multi-Output (MIMO) processes over the SISO processes. Due to the interactions, the control input of one loop also affect the other loops, which makes it difficult to control each loop independently [1].

Consider a distillation column example, in which, the output product concentration is controlled by the pressure and temperature of the column. It is difficult to control the temperature and pressure with the individual controller; because the temperature and pressure are related to each other. Therefore, a control strategy is required, which provide desired output with minimum interactions.

2 DESIGN CHALLENGES

A basic TITO control strategy is shown in Figure 1; where, $G_{ij}(s)$ is the process, $C_{ij}(s)$ is controller and $D_{ij}(s)$ is decoupler transfer function. The concepts of MIMO control systems are generally proved by considering Two-Input-Two-Output processes with the help of the transfer function matrices, as given bellow,

$$G(s) = \begin{bmatrix} G_{11} & G_{12} \\ G_{21} & G_{22} \end{bmatrix}. \quad (1)$$

The open loop transfer function between the input $r_1(t)$ and $y_1(t)$, when other loops are closed, is given by,

$$G_{11}^{ol} = G_{11}(s) - \frac{G_{12}(s)G_{21}(s)C_{22}(s)G_{22}(s)}{G_{22}(s)(1 + C_{22}(s)G_{22}(s))}. \quad (2)$$

Similarly, the open loop transfer function between the input $r_2(t)$ and $y_2(t)$ is given by,

$$G_{22}^{ol} = G_{22}(s) - \frac{G_{21}(s)G_{12}(s)C_{11}(s)G_{11}(s)}{(1 + C_{11}(s)G_{11}(s))G_{11}(s)}. \quad (3)$$

Equation (2) and (3) can be simplified as,

$$G_{11}^{eff}(s) = G_{11}(s) - \frac{G_{12}(s)G_{21}(s)}{G_{22}(s)}, \quad (4)$$

and
$$G_{22}^{eff}(s) = G_{22}(s) - \frac{G_{21}(s)G_{12}(s)}{G_{11}(s)}. \quad (5)$$

by considering the perfect control approximation, i.e.,

$$\frac{C_{ii}(s)}{1 + G_{ii}(s)C_{ii}(s)} = 1.$$

The transfer functions, given in (4) and (5), are known as Effective Open-loop Transfer function (EOTF). It is observed that the EOTF between the respective inputs and outputs is affected the other loops transfer function, which may have multiple time-delay terms. The EOTFs are the complex transfer function, and the complexity of the EOTFs are proportional to the dimensions of MIMO processes.

3 CONTROLLER DESIGN FOR MIMO PROCESSES

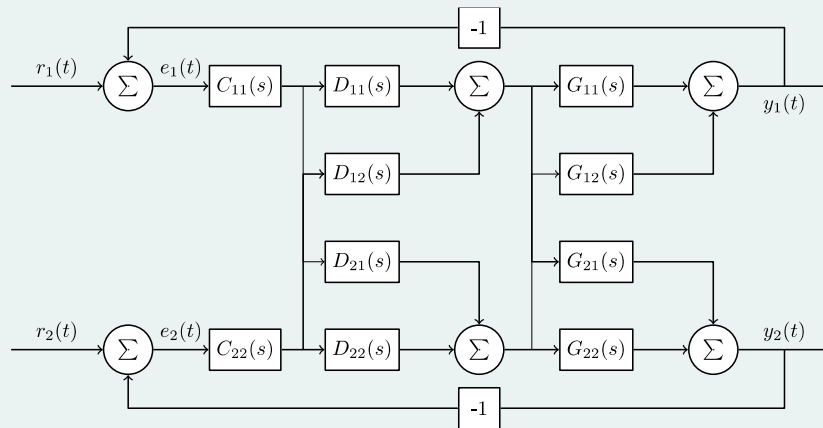

FIGURE 1: MULTI-INPUT MULTI-OUTPUT PROCESSES WITH DECOUPLER

Several MIMO control strategies are proposed in the literature, which are mainly classified into three categories: 1) Centralised (multi-loop) design [2]–[5], 2) Decoupler based design [6]–[8] and 3) Decentralised design [9]–[12].

3.1 CENTRALISED CONTROL DESIGN

The centralised control is a straightforward design approach to control MIMO process, in which, a $n \times n$ MIMO process controlled by total n^2 number of controllers, and a PID type centralised controller have $3n^2$ design parameters, which makes it a complex structure and a complicated design problem [2]–[5], [13].

The block diagram of the Centralised controller is given in Figure 2.

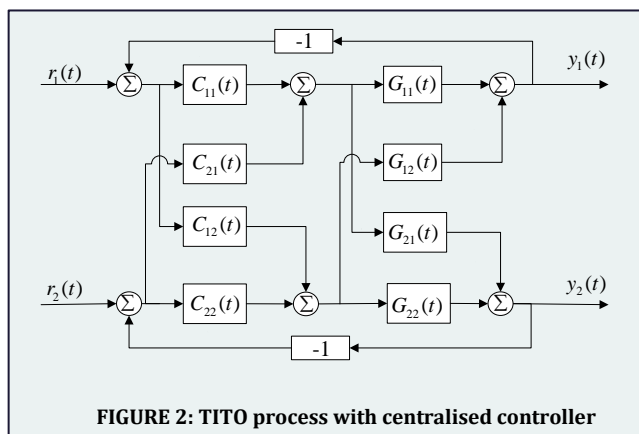

FIGURE 2: TITO process with centralised controller

3.2 DECOUPLER BASED DESIGN

The Decoupling strategy is a smart way to convert the MIMO process into the SISO processes by reducing the interaction among the loops with the help of a decoupler. The decoupler is a $n \times n$ transfer function matrix that is

derived from the process dynamics and converts $n \times n$ MIMO process into the n SISO processes. Mainly three types of decoupling strategies are reported in the literature: Ideal decoupling, Simplified decoupling [14] and Inverted decoupling [15]. A comparative study of Ideal decoupling and simplified decoupling can be found in [16].

The decoupling matrix is selected as,

$$D(s)G(s) = \hat{G}(s) = \begin{bmatrix} \hat{G}_{11} & 0 \\ 0 & \hat{G}_{22} \end{bmatrix}, \quad (6)$$

where $\hat{G}(s)$ is resulting diagonal matrix.

Regardless the advantages of decoupling strategy, its implementation has several practical limitations, such as causality and complexity. E.g., the simplified decoupling strategy required total n controllers and minimum n decoupler transfer functions (the number of decoupler transfer function will increase if any decoupler design is non-causal, see [8]) that will make it more complicated than the centralized controller.

3.3 DECENTRALISED DESIGN

Regardless the advantages of centralised and decoupled strategies, the decentralised control strategy is mostly used in industries because of the following four main reasons [17]:

- It required less number of design variable,
- Simple structure,
- Better failure tolerance, and
- A long record of satisfactory performance.

In decentralised control, the interaction among the loops are minimised by proper input-output pairing, and $n \times n$ MIMO process only needs a n number of controllers. The input-output pairing is decided by

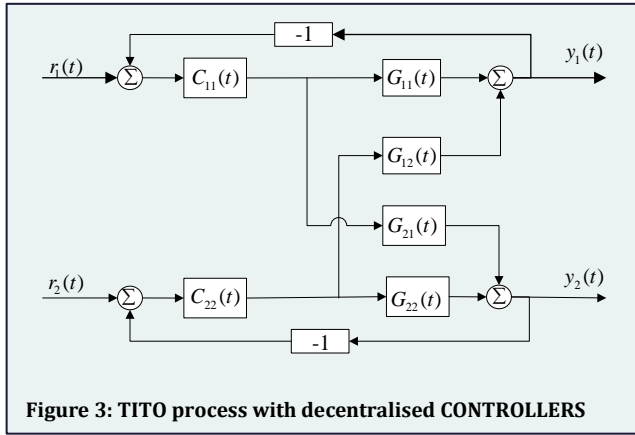

Figure 3: TITO process with decentralised CONTROLLERS

measuring the interaction matrices, such as RGA [18] and RGA [19], and Niederlinski Index.

3.3.1 Niederlinski Index

The Niederlinski index (NI) provides a necessary condition for loop pairing that has following mathematical expression,

$$Ni = \frac{\det(K)}{\prod(K_{ii})}, \quad (7)$$

where, K is steady state gain matrix of the process. The negative value NI indicates the unstable input-output pairing and positive value of NI is generally preferred and a perfectly decoupled process has unity Niederlinski index.

3.3.2 Relative Gain Array

The Relative gain array [18] is a method to identifies the interaction between the loops of MIMO process, which is described by,

$$\Lambda = K \otimes K^{-T}, \quad (8)$$

where Λ is called relative gain array, K is steady state gain of process $G_{ij}(s)$, \otimes indicates the multiplication element wise and K^{-T} represent the inverse of transpose of K .

3.3.3 Relative Normalised Gain Array

The RGA is the modification to RGA [19]. In RGA, integral error (residence time) is used to find new gain array, which incorporates process dynamics in RGA and that is referred as the Relative Normalised Gain Array (RNGA). The integral error (residence time) and the RNGA matrices are expressed as

$$T_{ar} = [\sigma_{ij}] = \int_0^{\infty} e(t)dt = \theta_{ij} + \tau_{ij}, \quad (9)$$

$$\phi(RNGA) = K_N \otimes K_N^{-T}. \quad (10)$$

where, $K_N = K \odot T_{ar}$ is the normalised steady state gain matrix and \odot is Hadamard division.

3.3.4 Equivalent Transfer function and Controller Design

Since, it has been discussed that the EOTFs are a complex transfer function and it is difficult to design a controller, directly, for them. Therefore, these EOTFs are approximated into the conventional FOPDT. The approximated transfer function is known as Equivalent Transfer Function (ETF) that is derived from the RGA and RNGA matrices.

Let us first define the Relative Average Residence Time array (RARTA) (also referred as Relative Frequency Array (RFA) [20]) that has the following expression,

$$\Gamma = [\gamma_{ij}] = \phi \odot \Lambda. \quad (11)$$

Form the definition of RARTA [19], [21], [22],

$$\gamma_{ij} = \frac{\hat{\sigma}_{ij}}{\sigma_{ij}}, \quad (12)$$

that gives,

$$\hat{\sigma}_{ij} = \gamma_{ij}\sigma_{ij} = \gamma_{ij}\theta_{ij} + \gamma_{ij}\tau_{ij}, \quad (13)$$

$$\hat{\sigma} = \hat{\theta}_{ij} + \hat{\tau}_{ij}. \quad (14)$$

From (13) and (14) following ETF can be designed,

$$\hat{G}_{ij}(s) = \hat{k}_{ij} \frac{e^{\hat{\theta}_{ij}s}}{\hat{\tau}_{ij}s + 1}, \quad (15)$$

where,

$$\hat{k}_{ij} = \frac{k_{ij}}{\Lambda_{ij}}, \quad (16)$$

$$\hat{\tau}_{ij} = \gamma_{ij}\tau_{ij}, \quad (17)$$

$$\hat{\theta}_{ij} = \gamma_{ij}\theta_{ij}. \quad (18)$$

The Equivalent Transfer Function, given in (15), is simplified FOPDT (first order plus Dead Time) transfer function of the actual process. The controller, for (15), can be designed easily with any existing FOPDT tuning rules [12], [23]–[25].

4 CONCLUSION

The challenges and design methods for MIMO processes are discussed in this paper. A brief introduction to loop interaction, interaction measurement methods and control strategies are given.

REFERENCES

- [1] W. S. Levine, *The Control Handbook*. CRC press, 1996.
- [2] V. Vijay Kumar, V. S. R. Rao, and M. Chidambaram, "Centralized PI controllers for interacting multivariable processes by synthesis method," *ISA Trans.*, vol. 51, no. 3, pp. 400–409, 2012.
- [3] J. Garrido, F. Vázquez, and F. Morilla, "Centralized multivariable control by simplified decoupling," *J. Process Control*, vol. 22, no. 6, pp. 1044–1062, 2012.
- [4] Q. Jin, X. Du, and B. Jiang, "Novel Centralized IMC-PID Controller Design for Multivariable Processes with Multiple Time Delays," *Ind. Eng. Chem. Res.*, vol. 56, no. 15, pp. 4431–4445, Apr. 2017.
- [5] J. Garrido, F. Vázquez, and F. Morilla, "Centralized inverted decoupling control," *Ind. Eng. Chem. Res.*, vol. 52, no. 23, pp. 7854–7866, 2013.
- [6] P. Nordfeldt and T. Hägglund, "Decoupler and PID controller design of TITO systems," *J. Process Control*, vol. 16, no. 9, pp. 923–936, 2006.
- [7] B. T. Jevtović and M. R. Mataušek, "PID controller design of TITO system based on ideal decoupler," *J. Process Control*, vol. 20, no. 7, pp. 869–876, 2010.
- [8] Q. G. Wang, B. Huang, and X. Guo, "Auto-tuning of TITO decoupling controllers from step tests," *ISA Trans.*, vol. 39, no. 4, pp. 407–418, 2000.
- [9] H. Cui and E. W. Jacobsen, "Performance limitations in decentralized control," *J. Process Control*, vol. 12, no. 4, pp. 485–494, 2002.
- [10] P. Balaguer and J. A. Romero, "Model order reduction for decentralized PID control design on TITO processes," in *IFAC Proceedings Volumes (IFAC-PapersOnline)*, 2012, vol. 2, no. PART 1, pp. 205–210.
- [11] V. D. Hajare and B. M. Patre, "Decentralized PID controller for TITO systems using characteristic ratio assignment with an experimental application," *ISA Trans.*, vol. 59, pp. 385–397, 2015.
- [12] M. He, W. Cai, B. Wu, and M. He, "Simple Decentralized PID Controller Design Method Based on Dynamic Relative Interaction Analysis," *Ind. Eng. Chem. Res.*, vol. 44, no. 22, pp. 8334–8344, 2005.
- [13] X. Luan, Q. Chen, and F. Liu, "Centralized PI control for high dimensional multivariable systems based on equivalent transfer function," *ISA Trans.*, vol. 53, no. 5, pp. 1554–1561, 2014.
- [14] Q.-G. Wang, Y. Zhang, and M.-S. Chiu, "Decoupling internal model control for multivariable systems with multiple time delays," *Chem. Eng. Sci.*, vol. 57, no. 1, pp. 115–124, 2002.
- [15] H. L. Wade, "Inverted decoupling: a neglected technique," *ISA Trans.*, vol. 36, no. 1, pp. 3–10, 1997.
- [16] K. Weischedel and T. J. McAvoy, "Feasibility of Decoupling in Conventionally Controlled Distillation Columns," *Ind. Eng. Chem. Fundam.*, vol. 19, pp. 379–384, 1980.
- [17] X. Luan, Q. Chen, and F. Liu, "Equivalent Transfer Function based Multi-loop PI Control for High Dimensional Multivariable Systems," *Int. J. Control. Autom. Syst.*, vol. 13, no. 2, pp. 1–7, 2015.
- [18] E. Bristol, "On a new measure of interaction for multivariable process control," *IEEE Trans. Automat. Contr.*, vol. 11, no. 1, pp. 133–134, 1966.
- [19] M. J. He, W. J. Cai, W. Ni, and L. H. Xie, "RNGA based control system configuration for multivariable processes," *J. Process Control*, vol. 19, no. 6, pp. 1036–1042, 2009.
- [20] Q. Xiong, W. J. Cai, and M. J. He, "Equivalent transfer function method for PI/PID controller design of MIMO processes," *J. Process Control*, vol. 17, no. 8, pp. 665–673, 2007.
- [21] W. J. Cai, W. Ni, M. J. He, and C. Y. Ni, "Normalized decoupling - a new approach for MIMO process control system design," *Ind. Eng. Chem. Res.*, vol. 47, no. 19, pp. 7347–7356, 2008.
- [22] C. Rajapandiyam and M. Chidambaram, "Controller Design for MIMO Processes Based on Simple Decoupled Equivalent Transfer Functions and Simplified Decoupler," *Ind. Eng. Chem. Res.*, vol. 51, pp. 12398–12410, 2012.
- [23] J. G. Ziegler and N. Nichols, "Optimum Settings for Automatic Controllers," *Transaction of the A.S.M.E.*, vol. 64, pp. 759–768, 1942.
- [24] G. H. Cohen and G. A. Coon, "Theoretical considerations of retarded control," *Trans. ASME*, vol. 75, no. 1, pp. 827–834, 1953.
- [25] W. L. Luyben, "Simple Method for Tuning SISO Controllers in Multivariable Systems," *Ind. Eng. Chem. Process Des. Dev.*, vol. 25, no. 3, pp. 654–660, 1986.

Review of power system state estimation techniques

Abhishek Sharma
ECE Department
PDPM-IIITDM, Jabalpur-482005.

Abstract: State estimation is an important area required for enabling proper operation and control of the power system and its real-time monitoring. Correct knowledge of the states (like rotor angle and speed deviations) enables us to develop control schemes to enhance the system stability and reliability. Earlier the power system loads were almost constant, and it was a static system as the load models became complex and the power system changed to quasi-static or sometimes dynamic it was not computationally possible to use older methods to achieve real-time monitoring. Dynamic State Estimation (DSE) techniques use the Dynamic model of the system in conjunction with the measurement model which can be used to accurately predict the states in advance. In this paper, various algorithms on state estimation are presented, based on the available literature.

1 INTRODUCTION

Prior to 1970, the need for accurate state estimation was unsubstantial but as the power system grew development of the power electronic devices and their inclusion in power system took place then it became difficult to carry on the older practices of determining the states of the system. Initially, Least square estimation was used which remained the choice for many researchers over many years but the disadvantages like High dependency on the model accuracy of the system, not suitable for real-time application[1]-[4] less numerical stability forced researchers to take their interest to newer algorithms. However, these algorithms were suitable for supervisory control and data acquisition (SCADA) systems, which used remote terminal units (RTUs) for data acquisition for wide area monitoring (WAMS). To improve the speed of the LSE [5] developed an algorithm for state estimation using decoupling between active and reactive equations and including an estimation of Regulating Transformer ratio [5] provided an improvement which decreased estimation time by 80%. Irving et al.[6] proposed linear programming for state estimation but its main disadvantage is that it is very difficult to take advantage of sparsity and the decoupled phenomena which speed up load flow studies this was pointed by [7]. The filter provided a recursive near optimal minimum variance estimate of the state of the non-linear system. The KF approach is reported to have less numerical precision & stability so [8] proposed use of square root filters which improved numerical reliability and the simulation results were nearly the same as conventional KF.

In recent years KF based algorithm have become quite popular because they can give results in real time

and some modified versions like EKF, UKF can be applied on the nonlinear systems which are perfect for power system based applications like[9] used UKF to determine the states and used them for protection schemes. But the problem associated with these algorithms is that they need accurate system modelling partial or uncertain model can be handled by robust iterative KF [10].

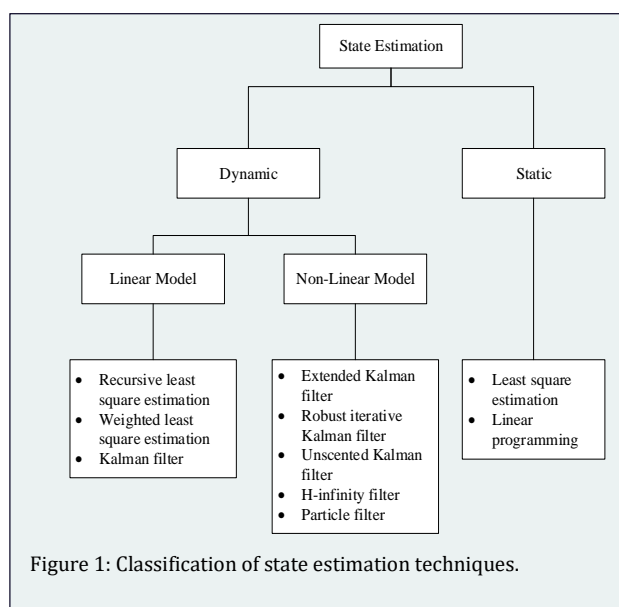

Figure 1: Classification of state estimation techniques.

2 STATE ESTIMATION TECHNIQUES

Many state estimation techniques exist in statistics, which are broadly categorized as static and dynamic methods as shown Figure 1. State estimation basically involves two steps Data acquisition and estimation algorithm the complete process is shown in Figure 2

which shows a flowchart of how the estimation is done. Majorly

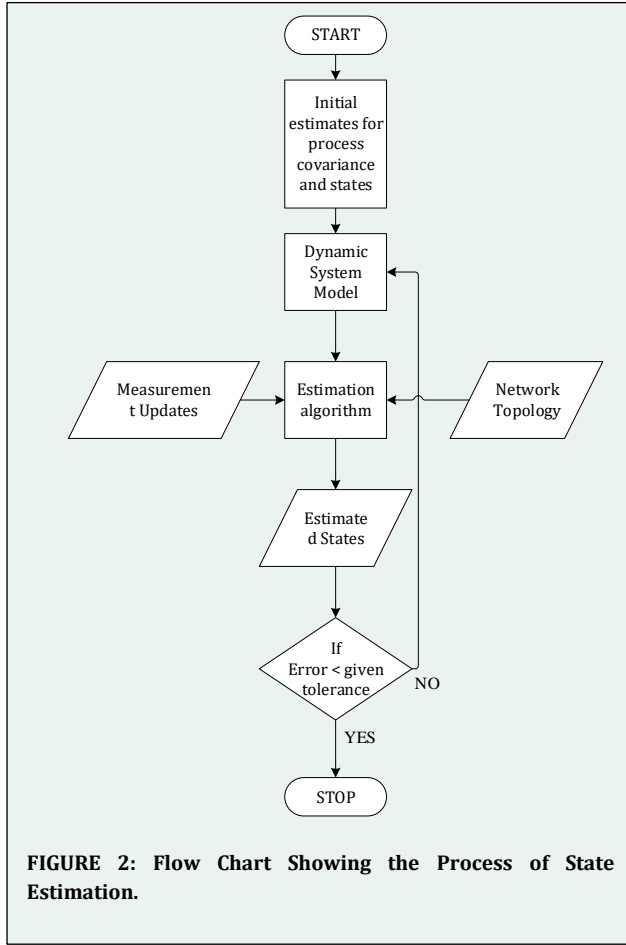

FIGURE 2: Flow Chart Showing the Process of State Estimation.

the techniques are recursive in nature and they can handle the noise very well these methods use previous information of the system and by using observation model they are able to predict the state vectors.

2.1 LEAST SQUARE ESTIMATION

LSE follows the principle that the most probable value of the unknown quantities will be that in which the sum of the squares of the difference between estimated values and true value is minimized. Formulations of LSE are as follows.

$$y = Hx + v \quad (1)$$

where y is the output vector H is the measurement/observation matrix, x is the state vector and v is the noise. Let be the error between the noisy measurement and the vector $H\hat{x}$

$$e_y = y - H\hat{x} \quad (2)$$

After minimizing the error function (cost function) we get the estimated state as

$$\hat{x} = (H^T H)^{-1} H^T y \quad (3)$$

2.2 WEIGHTED LEAST SQUARE ESTIMATION

While doing measurement one may not have full confidence in readings due to a different accuracy level of the instruments, therefore, raising reliability issues. To solve this each instrument is assigned a weight depending on the reliability level.

$$R = E(vv^T) \quad (4)$$

Where R is the weight. The best estimate is given by

$$\hat{x} = (H^T R^{-1} H)^{-1} H^T R^{-1} y \quad (5)$$

2.3 KALMAN FILTER

Kalman filter is an estimator which uses a set of measurements observed over time which may be corrupted with noise and conjoins it with the process model of the system to get the best estimate. It is basically prediction using system model followed by correction after measurement update type of problem. Suppose we have a linear discrete-time system for each time step $k = 1, 2, \dots, g$ given as follows

$$x_k = F_{k-1} x_{k-1} + w_{k-1} \quad (6)$$

$$y_k = H_k x_k + v_k \quad (7)$$

The noise processes w_{k-1} and v_k are white, zero-mean, uncorrelated, and have known covariance matrices Q_k and R_k respectively.

$$P_k^- = F_{k-1} P_{k-1}^+ F_{k-1}^T + Q_{k-1} \quad (8)$$

$$\hat{x}_k^- = F_{k-1} \hat{x}_{k-1}^+ \quad (9)$$

$$K_k = P_k^- H_k^T (H_k P_k^- H_k^T + R_k)^{-1} \quad (10)$$

$$\hat{x}_k^+ = \hat{x}_k^- + K_k (y_k - H_k \hat{x}_k^-) \quad (11)$$

$$P_k^+ = (I - K_k H_k) P_k^- (I - K_k H_k)^T + K_k R_k K_k^T \quad (12)$$

2.4 EXTENDED KALMAN FILTER

Extended Kalman filter[11] is based on the linearizing the non-linear system. This is done by linearizing the system around a nominal state trajectory and the Kalman filter estimate is considered as the nominal state around which we can linearize the system. Consider the nonlinear process and observation as:

$$x_k = f_{k-1}(x_{k-1}, u_{k-1}, w_{k-1}) \quad (13)$$

$$y_k = h_k(x_k, v_k) \quad (14)$$

1. Compute the following partial derivative matrices

$$\begin{aligned} F_{k-1} &= \frac{\partial f_{k-1}}{\partial x} \Big|_{\hat{x}_{k-1}^+} \\ L_{k-1} &= \frac{\partial f_{k-1}}{\partial w} \Big|_{\hat{x}_{k-1}^+} \end{aligned} \quad (15)$$

2. Perform the time update state estimate and the error covariance as follows:

$$P_k^- = F_{k-1} P_{k-1}^+ F_{k-1}^T + L_{k-1} Q_{k-1} L_{k-1}^T \quad (16)$$

$$\hat{x}_k^- = f_{k-1}(\hat{x}_{k-1}^+, u_{k-1}, 0) \quad (17)$$

3. Compute the following partial derivative matrices:

$$\begin{aligned} H_k &= \frac{\partial h_k}{\partial x} \Big|_{\hat{x}_k^-} \\ M_k &= \frac{\partial h_k}{\partial v} \Big|_{\hat{x}_k^-} \end{aligned} \quad (18)$$

4. Perform the measurement update of the state estimate and estimation- error covariance as follows:

$$K_k = P_k^- H_k^T (H_k P_k^- H_k^T + M_k R_k M_k^T)^{-1} \quad (19)$$

$$\hat{x}_k^+ = \hat{x}_k^- + K_k [y_k - h_k(\hat{x}_k^-, 0)] \quad (20)$$

$$P_k^+ = (I - K_k H_k) P_k^- \quad (21)$$

However, this algorithm has a drawback that linearizing the nonlinear system dynamics and observation models may introduce errors in the estimation of the state and in some cases, the filter may diverge for highly nonlinear function[12].

2.5 UNSCENTED KALMAN FILTER

An unscented transformation[11] is based on two fundamental principles. First, it is easy to perform a nonlinear transformation on a single point (rather than an entire probability density function). Second, it is not too hard to find a set of individual points in state space whose sample pdf approximates the true pdf of a state vector.

Taking these two ideas together, suppose that we know the mean \bar{x} and covariance P of a vector x . We then find a set of deterministic vectors called sigma points whose ensemble mean and covariance are equal to \bar{x} and P we next apply our known nonlinear function

$y = h(x)$ to each deterministic vector to obtain transformed vectors. The ensemble mean and covariance of the transformed vectors will give a good estimate of the true mean and covariance of y [11]. Consider the non-linear system described by Equation 13 and 14. Sigma points are generated as:

$$\hat{x}_{k-1}^{(i)} = \hat{x}_{k-1}^+ + \tilde{x}^{(i)} \quad i = 1, \dots, 2n \quad (22)$$

$$\tilde{x}^{(i)} = \left(\sqrt{n P_{k-1}^+} \right)_i^T \quad i = 1, \dots, n \quad (23)$$

$$\tilde{x}^{(n+i)} = - \left(\sqrt{n P_{k-1}^+} \right)_i^T \quad i = 1, \dots, n \quad (24)$$

Each sigma point is passed through the model of state evolution to obtain the predicted-state sigma points given:

$$\hat{x}_k^{(i)} = f(\hat{x}_{k-1}^{(i)}, u_k, t_k) \quad (25)$$

Subsequently, the weighted mean and covariance of the predicted sigma points $\hat{x}_k^{(i)}$ and P_k^- .

$$x_k^- = \frac{1}{2n} \sum_{i=1}^{2n} \hat{x}_k^{(i)} \quad (26)$$

$$P_k^- = \frac{1}{2n} \sum_{i=0}^{2n} (\hat{x}_k^{(i)} - \hat{x}_k^-) (\hat{x}_k^{(i)} - \hat{x}_k^-)^T \quad (27)$$

Use the known nonlinear measurement equation $h(\cdot)$ to transform the sigma points and consequently the weighted mean of the predicted measurement $\hat{y}_k^{(i)}$, the corresponding covariance matrix P_y and the cross-covariance matrix P_{xy} are given as:

$$\hat{y}_k = \frac{1}{2n} \sum_{i=1}^{2n} \hat{y}_k^{(i)} \quad (28)$$

$$P_y = \frac{1}{2n} \sum_{i=1}^{2n} (\hat{y}_k^{(i)} - \hat{y}_k) (\hat{y}_k^{(i)} - \hat{y}_k)^T + R_k \quad (29)$$

$$P_{xy} = \frac{1}{2n} \sum_{i=1}^{2n} (\hat{x}_k^{(i)} - \hat{x}_k^-) (\hat{y}_k^{(i)} - \hat{y}_k)^T \quad (30)$$

TABLE 1 : State Estimation Techniques

Technique	Key-References	Merits	Demerits	Applications
LSE	[5], [6], [13]	<ul style="list-style-type: none"> • Simple. • Fast. 	<ul style="list-style-type: none"> • System state space model is not accounted. • Tend to smear the effect of bad data. 	<ul style="list-style-type: none"> • Used in static state estimation.
WLS	[14]–[18]	<ul style="list-style-type: none"> • Utilizes even less accurate measurements • Fairly accurate. 	<ul style="list-style-type: none"> • Affected by measurement type, location and error • Requires excessive storage. 	<ul style="list-style-type: none"> • Commonly used in industries.
RLSE	[19]–[22]	<ul style="list-style-type: none"> • Simple structure. • Less computation demanding. 	<ul style="list-style-type: none"> • Not robust against noise. • Moderate dynamic performance. 	<ul style="list-style-type: none"> • Online state estimation. • Simplified state space identification
KF	[23]–[25]	<ul style="list-style-type: none"> • Robust against noise. • Ability to track time varying parameters. 	<ul style="list-style-type: none"> • State modelling is critical. • Priority information of process is needed. 	<ul style="list-style-type: none"> • Noisy time-varying process. • Online linear dynamic estimation applications.
EKF	[26]–[31]	<ul style="list-style-type: none"> • Suitable for non-linear process. • Performs even after topological changes. 	<ul style="list-style-type: none"> • Performance depends on measurement update rate • Diverges as error between actual measurement and the one derived from predicted state increases. 	<ul style="list-style-type: none"> • Widely used for power system state estimation. • Successfully tracks dynamic states
RIKF	[10], [32]–[35]	<ul style="list-style-type: none"> • Good at rejecting repetitive disturbances • Improve the estimation performance from batch to batch. 	<ul style="list-style-type: none"> • Complex problem formulation. • Robustness depends on calculation of outliers. 	<ul style="list-style-type: none"> • Tackles the nonlinearity involved in repetitive processes
UKF	[30], [36]–[41]	<ul style="list-style-type: none"> • Estimation without linearizing with same computational effort as of EKF • High performance under very nonlinear systems 	<ul style="list-style-type: none"> • Sigma points are deterministically chosen, so that certain properties of these points do not match those of the prior distribution • May lead to numerical instability 	<ul style="list-style-type: none"> • Adaptive relaying and protection. • Predictive control of electric machines.
Particle filter	[42]–[47]	<ul style="list-style-type: none"> • Better accuracy particularly for highly non-linear systems • Can be applied on systems with non-Gaussian noise 	<ul style="list-style-type: none"> • Computational burden is very high • Due to high complexity difficult to implement 	<ul style="list-style-type: none"> • Provide accurate global estimation

Finally, the measurement update of the state estimate can be performed using the normal Kalman filter equations as shown in the equation below:

$$K_k = P_{xy} P_y^{-1} \quad (31)$$

$$\hat{x}_k^+ = \hat{x}_k^- + K_k (y_k - \hat{y}_k) \quad (32)$$

$$P_k^+ = P_k^- - K_k P_y K_k^T \quad (33)$$

3 KEY ISSUES AND CHALLENGES

State estimation is especially important for real-time operation and control of power system it is important to know the estimated states for other controllers and devices (like relays). State estimation should be fast so that it can be applied in real time, highly accurate for better reliability, less complex for practical implementation. Nowadays power system is becoming highly dynamic and complex in nature, so the estimation algorithm should be adaptive. The estimation algorithm should be robust against measurement noise. The key challenges and issues in power system state estimation are as follows:

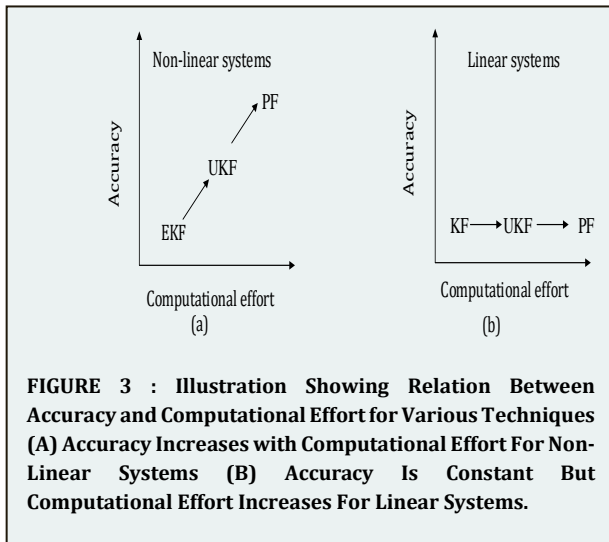

FIGURE 3 : Illustration Showing Relation Between Accuracy and Computational Effort for Various Techniques (A) Accuracy Increases with Computational Effort For Non-Linear Systems (B) Accuracy Is Constant But Computational Effort Increases For Linear Systems.

1. Power system modelling is the major issue in implementing the state estimation and it is further complicated by frequently varying loads, the inclusion of power electronic devices and integration of non-renewable energy source into the grid.
2. Measurements from instruments are very often polluted with noise and these data affects the state estimation techniques especially WLS, LP, and RLSE.
3. The computational effort required by the techniques like EKF, UKF, RIKF, and PF is considerably high which makes them difficult and expensive to implement, but in return, these algorithms give
4. good accuracy for nonlinear systems as shown in Figure 3.
5. Presently for wide area monitoring (WAMs) phasor measurement units (PMUs) are used which are easily corrupted by harmonics in the system so this corrupted data will lead to incorrect estimation of states.
6. Applications like Power system protection fast estimation so that relay settings could be quickly configured, and circuit breakers can be prevented from false or no tripping. If the computational time of the algorithms is reduced, then it would be beneficial to more dynamic problems which require fast response.

4 CONCLUSION

A comprehensive literature survey is carried out on the power system state estimation techniques, advantages, disadvantages and problems related to each technique is also presented. These algorithms are the foundation of state estimation and their advancements will provide more accurate, fast and stable estimates which can be fed to various other control schemes related to power system operation. Least square has been the first choice for state estimation for years because of its simplicity but in

today's scenario they don't fit so KF and particle filter-based techniques are becoming popular among researchers because it is robust and simple which is making them a better technique for state estimation.

REFERENCES

- [1] R. E. Larson, W. F. Tinney, and J. Peschon, "State Estimation in Power Systems Part I: Theory and Feasibility," *IEEE Trans. Power Appar. Syst.*, vol. PAS-89, no. 3, pp. 345–352, Mar. 1970.
- [2] F. C. Schweppe and D. B. Rom, "Power System Static-State Estimation, Part II: Approximate Model," *IEEE Trans. Power Appar. Syst.*, vol. PAS-89, no. 1, pp. 125–130, Jan. 1970.
- [3] F. C. Schweppe and J. Wildes, "Power System Static-State Estimation, Part I: Exact Model," *IEEE Trans. Power Appar. Syst.*, vol. PAS-89, no. 1, pp. 120–125, Jan. 1970.
- [4] F. C. Schweppe, "Power System Static-State Estimation, Part III: Implementation," *IEEE Trans. Power Appar. Syst.*, vol. PAS-89, no. 1, pp. 130–135, Jan. 1970.
- [5] G. H. Couch, "Improved power system state estimation with constant gain matrices," *Proc. IEEE*, vol. 64, no. 11, pp. 1641–1643, Nov. 1976.
- [6] M. R. Irving, R. C. Owen, and M. J. H. Sterling, "Power-system state estimation using linear programming," *Electr. Eng. Proc. Inst.*, vol. 125, no. 9, pp. 879–885, Sep. 1978.
- [7] A. Brameller and S. H. Karaki, "Power-system state estimation using linear programming," *Electr. Eng. Proc. Inst.*, vol. 126, no. 3, pp. 246–247, Mar. 1979.
- [8] I. M. Ferreira and F. P. M. Barbosa, "A square root filter algorithm for dynamic state estimation of electric power systems," in *Electrotechnical Conference, 1994. Proceedings., 7th Mediterranean*, 1994, pp. 877–880 vol.3.
- [9] L. Zanni, J. Y. Le Boudec, R. Cherkaoui, and M. Paolone, "A Prediction-Error Covariance Estimator for Adaptive Kalman Filtering in Step-Varying Processes: Application to Power-System State Estimation," *IEEE Trans. Control Syst. Technol.*, vol. 25, no. 5, pp. 1683–1697, Sep. 2017.
- [10] S. J. Kwon, "Robust Kalman filtering with perturbation estimation process for uncertain systems," *IEE Proc. - Control Theory Appl.*, vol. 153, no. 5, pp. 600–606, Sep. 2006.
- [11] D. Simon, *Optimal State Estimation: Kalman, H ∞ , and Nonlinear Approaches*. 2006.
- [12] N. Amor and S. Chebbi, "Performance comparison of particle swarm optimization and extended Kalman filter methods for tracking in non-linear dynamic systems," in *2017 International Conference on Control, Automation and Diagnosis (ICCAD)*, 2017, pp. 116–119.
- [13] A. Akhlaq, R. McKilliam, and A. Pollok, "Robustness of the least squares range estimator," in *2016 Australian Communications Theory Workshop (AusCTW)*, 2016, pp. 147–152.

- [14] J. C. K, S. R., and A. T. Mathew, "State estimation using Weighted Least Square method with minimum measurement data," in *2015 International Conference on Control Communication Computing India (ICCC)*, 2015, pp. 275–279.
- [15] T. P. Vishnu, V. Viswan, and A. M. Vipin, "Power system state estimation and bad data analysis using weighted least square method," in *2015 International Conference on Power, Instrumentation, Control and Computing (PICC)*, 2015, pp. 1–5.
- [16] J. W. Kang and D. H. Choi, "Distributed multi-area WLS state estimation integrating measurements weight update," *IET Gener. Transm. Distrib.*, vol. 11, no. 10, pp. 2552–2561, 2017.
- [17] M. Meriem, C. Bouchra, B. Abdelaziz, S. O. B. Jamal, E. M. Faissal, and C. Nazha, "Study of state estimation using weighted-least-squares method (WLS)," in *2016 International Conference on Electrical Sciences and Technologies in Maghreb (CISTEM)*, 2016, pp. 1–5.
- [18] P. Tripathi, J. Rahul, and N. A. Radhamohan, "Analysis of state estimation for power system using weighted least square method," in *2014 IEEE International Conference on Computational Intelligence and Computing Research*, 2014, pp. 1–5.
- [19] B. Hoff and W. Sulkowski, "Online estimation of induction motor state space system using Recursive Least-Squares," in *2010 17th IEEE International Conference on Electronics, Circuits and Systems*, 2010, pp. 1120–1123.
- [20] T. Bessaoudi, K. Khémiri, F. B. Hmida, and M. Gossa, "Recursive least-squares estimation for the joint input-state estimation of linear discrete time systems with unknown input," in *Eighth International Multi-Conference on Systems, Signals Devices*, 2011, pp. 1–6.
- [21] Z. Liu and C. Li, "Recursive Least Squares for Censored Regression," *IEEE Trans. Signal Process.*, vol. 65, no. 6, pp. 1565–1579, Mar. 2017.
- [22] M. Beza and M. Bongiorno, "A Modified RLS Algorithm for Online Estimation of Low-Frequency Oscillations in Power Systems," *IEEE Trans. Power Syst.*, vol. 31, no. 3, pp. 1703–1714, May 2016.
- [23] H. Tebianian and B. Jeyasurya, "Dynamic state estimation in power systems using Kalman filters," in *2013 IEEE Electrical Power Energy Conference*, 2013, pp. 1–5.
- [24] Z. Huang, K. Schneider, and J. Nieplocha, "Feasibility studies of applying Kalman Filter techniques to power system dynamic state estimation," in *2007 International Power Engineering Conference (IPEC 2007)*, 2007, pp. 376–382.
- [25] A. S. Debs and R. E. Larson, "A Dynamic Estimator for Tracking the State of a Power System," *IEEE Trans. Power Appar. Syst.*, vol. PAS-89, no. 7, pp. 1670–1678, Sep. 1970.
- [26] E. Ghahremani and I. Kamwa, "Dynamic State Estimation in Power System by Applying the Extended Kalman Filter With Unknown Inputs to Phasor Measurements," *IEEE Trans. Power Syst.*, vol. 26, no. 4, pp. 2556–2566, Nov. 2011.
- [27] H. Karimipour and V. Dinavahi, "Extended Kalman Filter-Based Parallel Dynamic State Estimation," *IEEE Trans. Smart Grid*, vol. 6, no. 3, pp. 1539–1549, May 2015.
- [28] S. Akhlaghi and N. Zhou, "Adaptive multi-step prediction based EKF to power system dynamic state estimation," in *2017 IEEE Power and Energy Conference at Illinois (PECI)*, 2017, pp. 1–8.
- [29] M. Yazdani, A. Mehrizi-Sani, and M. Mojiri, "Estimation of electromechanical oscillation parameters using an extended Kalman filter," in *2016 IEEE Power and Energy Society General Meeting (PESGM)*, 2016, p. 1.
- [30] M. Rampelli and D. Jena, "Advantage of Unscented Kalman Filter over Extended Kalman Filter in dynamic state estimation of power system network," in *Michael Faraday IET International Summit 2015*, 2015, pp. 278–283.
- [31] D. D. Trivedi, S. C. Vora, and M. R. Karamta, "Analysis of extended Kalman filter based dynamic state estimator's performance under anomalous measurement conditions for power system," *2016 Int. Conf. Electr. Power Energy Syst.*, pp. 557–563, Dec. 2016.
- [32] J. Zhao, M. Netto, and L. Mili, "A Robust Iterated Extended Kalman Filter for Power System Dynamic State Estimation," *IEEE Trans. Power Syst.*, vol. 32, no. 4, pp. 3205–3216, Jul. 2017.
- [33] W. Liu and Z. Deng, "Robust steady-state Kalman filter for uncertain discrete-time system," in *2015 International Conference on Estimation, Detection and Information Fusion (ICEDIF)*, 2015, pp. 190–194.
- [34] B. Chen, L. Yu, and W. A. Zhang, "Robust Kalman filtering for uncertain state delay systems with random observation delays and missing measurements," *IET Control Theory Appl.*, vol. 5, no. 17, pp. 1945–1954, Nov. 2011.
- [35] S. M. K. Mohamed and S. Nahavandi, "Robust Finite-Horizon Kalman Filtering for Uncertain Discrete-Time Systems," *IEEE Trans. Automat. Contr.*, vol. 57, no. 6, pp. 1548–1552, Jun. 2012.
- [36] J. Qi, K. Sun, J. Wang, and H. Liu, "Dynamic State Estimation for Multi-Machine Power System by Unscented Kalman Filter with Enhanced Numerical Stability," *IEEE Trans. Smart Grid*, vol. PP, no. 99, p. 1, 2016.
- [37] P. Regulski and V. Terzija, "Estimation of Frequency and Fundamental Power Components Using an Unscented Kalman Filter," *IEEE Trans. Instrum. Meas.*, vol. 61, no. 4, pp. 952–962, Apr. 2012.
- [38] S. J. Julier and J. K. Uhlmann, "Unscented filtering and nonlinear estimation," *Proc. IEEE*, vol. 92, no. 3, pp. 401–422, Mar. 2004.
- [39] J. Zhang, A. Swain, N. K. C. Nair, and J. J. Liu, "Estimation of power quality using an unscented Kalman filter," in *TENCON 2007 - 2007 IEEE Region 10 Conference*, 2007, pp. 1–4.
- [40] G. Valverde and V. Terzija, "Unscented kalman filter for power system dynamic state estimation," *IET Gener.*

Transm. Distrib., vol. 5, no. 1, pp. 29–37, Jan. 2011.

- [41] M. A. M. Ariff and B. C. Pal, "Adaptive Protection and Control in the Power System for Wide-Area Blackout Prevention," *IEEE Trans. Power Deliv.*, vol. 31, no. 4, pp. 1815–1825, Aug. 2016.
- [42] K. Emami, T. Fernando, and B. Nener, "Power system dynamic state estimation using particle filter," in *IECON 2014 - 40th Annual Conference of the IEEE Industrial Electronics Society*, 2014, pp. 248–253.
- [43] K. Emami, T. Fernando, H. Iu, H. Trinh, and K. P. Wong, "Particle filter approach to dynamic state estimation of generators in power systems," in *2016 IEEE Power and Energy Society General Meeting (PESGM)*, 2016, p. 1.
- [44] K. Emami, T. Fernando, H. H. C. Iu, H. Trinh, and K. P. Wong, "Particle Filter Approach to Dynamic State Estimation of Generators in Power Systems," *IEEE Trans. Power Syst.*, vol. 30, no. 5, pp. 2665–2675, Sep. 2015.
- [45] A. Khandelwal and A. Tondan, "Power system state estimation comparison of Kalman filters with a new approach," in *2016 7th India International Conference on Power Electronics (IICPE)*, 2016, pp. 1–6.
- [46] B. Uzunoglu, M. AkifÜlker, and D. Bayazit, "Particle filter joint state and parameter estimation of dynamic power systems," in *2016 57th International Scientific Conference on Power and Electrical Engineering of Riga Technical University (RTUCON)*, 2016, pp. 1–7.
- [47] D. Meng, N. Zhou, S. Lu, and G. Lin, "Estimate the electromechanical states using particle filtering and smoothing," in *2012 IEEE Power and Energy Society General Meeting*, 2012, pp. 1–7.

Identification and Modelling of systems using Artificial Neural Networks

Sudeep Sharma
ECE Department
PDDM-IIITDM, Jabalpur-482005.

Abstract: *This paper presents brief discussion of parametric identification and modelling of unknown system dynamics using ANN (Artificial Neural Networks). Various ANN architectures and learning methods that developed throughout the years depending upon the need of application and computation capabilities been discussed briefly, including essential properties only, to cover the major objective of the work. The paper concludes with some thoughts on future requirements and possible developments ANN identification and modelling.*

Keywords: Identification, Artificial Neural Network, Learning, modelling.

1 INTRODUCTION

The idea behind development of ANN (artificial neural networks) has its roots in neurobiology. The topology and functionality of ANN has motivated by the architecture of the human brain. Rumelhart et al. [1] proposed the multilayer perceptron (MLP), which is a network that builds upon the McCulloch and Pitts' [2] model of neurons and Rosenblatt's [3] perceptron model. Another interesting view presented in Lippmann [4], and Lapedes and Farber [5] is that the network provides an approximation to an underlying function.

With the evolution of intelligent control systems in the present millennium, plant modeling has undergone a shift from modeling by using first principles (physical laws) to the data driven approaches. This has resulted in applying polynomial approximation methods to neural networks, such as Volterra polynomial network [6] and the orthogonal network [7]. The application of wavelet transforms to neural networks [8] has also derived its inspiration from function approximation. Neural networks have been widely applied to many areas such as classification [9], filtering [10], identification [11-13], communication [14], etc.

This paper concerns about the use of ANN in parametric identification only. Considering the fact that the parametric identification using ANN is very tedious task because of its complex and non-unique topological structure. As the parametric identification of process, dynamics plays a vital role in design and tuning of controller parameters. Therefore, the data driven ANN based parametric identification of unknown process models utilized effectively in process industry. The rest of the paper organized as follows. In Section 2, the parametric ANN identification methods have discussed. In next Section, 3 the proposed idea has been introduced and conclusions are drawn in Section 4.

2 ANN METHODS OF PARAMETRIC IDENTIFICATION

Out of many research publications in the domain of ANN identification, only a few developed the mathematical relationship between the ANN weights and the parameters of the identified systems.

Fung et al. [15] developed an algorithm, which maps ANN into the GFRF (generalized frequency response functions). Which involves the training time neural network to transform into frequency domain. However, their work was general and mathematically involved, which did not provide a clear approach for model development and the developed model is very sensitive to network topology and training parameters.

Chon and Cohen [16] estimated the parameters for linear and nonlinear ARMA models using neural network weights. In their work, the ANN architecture is a MLP (multilayer perceptron) with polynomial activation function in hidden layer. However, their work was restricted to polynomial activation functions and the accuracy of identification depends upon exact model order selection and the number of hidden units used in the ANN architecture.

Lopez and Caicedo [17] used MLP for parametric identification. In their research, they have not discussed the complexity issue of MLP parameterization on how to choose the number of layers and number of neurons for a specific system identification.

Fei et al. [18] proposed a linear recurrent neural network for the identification of multi-variable systems, but their identification accuracy depends upon the choice of learning algorithm and corresponding learning rate.

Tutunji [19] used multilayer feed-forward ANN for parametric identification by utilizing linear as well as nonlinear activation functions in hidden layer. However,

he linearized the nonlinear activation at zero using Taylor's series approximation, which brings inaccuracy in results.

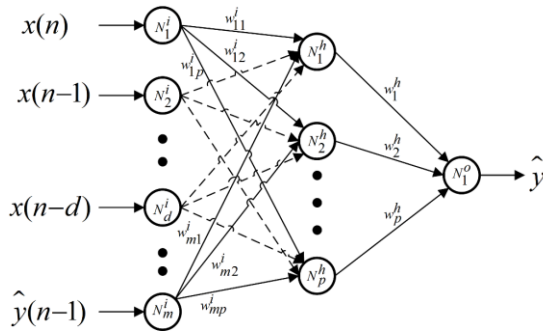

FIG. 1. PROPOSED THREE-LAYER LINEAR RECURRENT ANN TOPOLOGY

3 PROPOSED IDENTIFICATION TECHNIQUE

This section introduces proposed ANN method to identify an unknown stable process, which is motivated by [16] and [19] and uses linear activation function and ability to estimate delay in the system. Fig. 1 shows the proposed ANN topology for identification of unknown systems in the form of FOPDT models. The proposed ANN has three layers (input, hidden and output). The input layer uses total m number of neurons out of which $(m - 1)$ neurons are used by input lag terms and remaining one neuron is used by feedback output unit sampled delay term. The hidden layer uses p number of neurons and each hidden neuron are connected to each input neurons through a dedicated network weight.

The output layer has one neuron that has p number of incoming weighted links from hidden nodes. All neurons in each layer use linear activation function to produce the output. The simplified equivalent ANN structure of Fig. 1, shown in Fig. 2 and the estimated output is given by the following expression as,

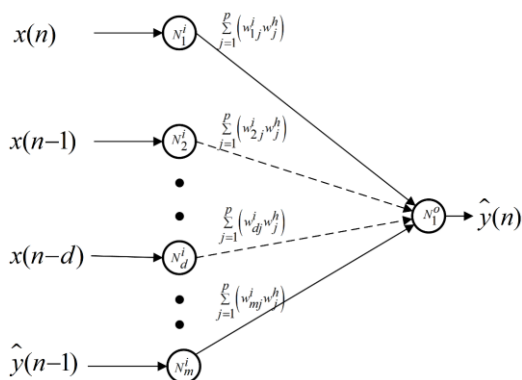

FIG. 2. SIMPLIFIED STRUCTURE OF PROPOSED ANN TOPOLOGY

$$\hat{y}(n) = \sum_{j=1}^p ((w_{1j}^i w_j^h)x(n) + \dots + (w_{mj}^i w_j^h)\hat{y}(n-1)). \quad (1)$$

In the difference, equation form of (1) $\hat{y}(n)$ and $\hat{y}(n-1)$ are n^{th} and $(n-1)^{th}$ estimated sampled outputs respectively and $x(n)$ to $x(n-d)$ are n^{th} and $(n-d)^{th}$ sampled inputs respectively. The neural network weights are optimized through supervised learning using Levenberg Marquardt algorithm [20].

4 CONCLUSION

This paper discusses about the main contributions along with their limitations in producing transparent models using ANN. The accuracy of parametric identification using ANN is mainly depends upon the choice of network architecture and parameter optimizing algorithm. As the parametric identification, using ANN can give us flexibility in simple, accurate, fast and adaptive controller design for the underlying systems. Therefore, it has seen as a good alternative of system identifier in process industries. The proposed method gives us a simple idea to identify systems in terms of discrete equations using neural networks. The future contributions in this field can be towards development of techniques to include delays, controller tuning within the ANN structure etc.

REFERENCES

- [1] R. J. W. Rumelhart, David E., Geoffrey E. Hinton, "Learning internal representations by error propagation.," Calif. Univ San Diego La Jolla Inst Cogn. Sci., vol. No. ICS-85, no. V, 1985.
- [2] W. S. McCulloch and W. Pitts, "A logical calculus nervous activity*," vol. 52, no. 1, pp. 99-115, 1990.
- [3] F. Rosenblatt and C. Nonr-, "THE PERCEPTRON : A PROBABILISTIC MODEL FOR INFORMATION STORAGE AND ORGANIZATION," vol. 65, no. 6, pp. 386-408.
- [4] R. P. Lippmann, "An Introduction to Computing with Neural Nets."
- [5] R. M. F. Lapedes, Alan S., "How neural nets work," Neural Inf. Process. Syst., pp. 442-456, 1988.
- [6] M. R. L. Rayner, P. J. W., "A new connectionist model based on a non-linear adaptive filter.," Int. Conf. on. IEEE, no. Acoustics, Speech, and Signal Processing, 1989, pp. 1191-1194, 1989.
- [7] S. Qiant, Y. C. Leett, R. D. Jones, C. W. Barnes, and K. Lee, "FUNCTION APPROXIMATION WITH AN ORTHOGONAL BASIS NET," no. x.
- [8] Y. C. Pati and P. S. Krishnaprasad, "Analysis and Synthesis of Feedforward Neural Networks Using Discrete Affine Wavelet Transformations," vol. 1, no. I.
- [9] Y. Bengio, "Radial Basis Functions for Speech Recognition," in Speech Recognition and Understanding, 1992, pp. 293-298.
- [10] G. D. Tattersall, S. Foster, and R. D. Johnston, "Single-layer lookup perceptrons," vol. 138, no. I, 1991.
- [11] S. Chen, S. A. Billings, C. F. N. Cowan, and P. M. Grant, "Practical identification of NARMAX models using radial basis functions," Int. J. Control, no. 769892610,

- 1990.
- [12] K. S. N. Parthasarathy, Kannan, "Identification and Control of Dynamical Systems Using Neural Networks," vol. I, no. I, 1990.
- [13] and S. A. B. Chen, S. A. B. S., "Neural networks for nonlinear dynamic system modelling and identification," *Int. J. Control*, vol. 52, no. 2, pp. 319–346, 1992.
- [14] N. Ahad, J. Qadir, and N. Ahsan, "Neural networks in wireless networks: Techniques, applications and guidelines," *J. Netw. Comput. Appl.*, vol. 68, pp. 1–27, 2016.
- [15] C. F. Fung, S. A. Billings, and H. Zhang, "Generalised transfer functions of neural networks," *Mech. Syst. Signal Process.*, vol. 11, no. 6, pp. 843–868, 1997.
- [16] K. H. Chon and R. J. Cohen, "Linear and nonlinear ARMA model parameter estimation using an artificial neural network," *IEEE Trans. Biomed. Eng.*, vol. 44, no. 3, pp. 168–174, 1997.
- [17] J. A. Lopez and E. Caicedo, "Parametric identification using multilayer perceptron," in *Industrial Electronics and Control Applications, 2005. ICIECA 2005. International Conference on, 2005*, p. 4--pp.
- [18] M. Fei, J. Zhang, H. Hu, and T. Yang, "A novel linear recurrent neural network for multivariable system identification," *Trans. Inst. Meas. Control*, vol. 28, no. 3, pp. 229–242, 2006.
- [19] T. A. Tutunji, "Parametric system identification using neural networks," *Appl. Soft Comput.*, vol. 47, pp. 251–261, 2016.
- [20] M. T. Hagan and M. B. Menhaj, "Training feedforward networks with the Marquardt algorithm," *IEEE Trans. Neural Networks*, vol. 5, no. 6, pp. 989–993, 1994.

Overview of Non-Intrusive Load Monitoring

Vijay Rathore
ECE Department
PDPM-IIITDM, Jabalpur-482005.

Abstract: From past several years, Non-Intrusive Load Monitoring (NILM) played a crucial role in energy management where the unique load signatures are used to classify different loads with the use of single smart meter data, which makes it less expensive. Disaggregation using NILM includes different algorithms and classification techniques, like Wavelet Transform Analysis, Waveform based Modelling, and Basic Power Analysis which uses unique extraction features, say, current waveform (CW), active/reactive power (PQ), harmonics (HAR), instantaneous power waveform (IPW), eigenvalues (EIG) and switching-transient waveform (STW). This paper discusses the developments and challenges of NILM.

Keywords: NILM, load signatures, load disaggregation techniques.

1 INTRODUCTION

Non-renewable energy sources like oil, coal, natural gas is estimated to be extinct by the twenty-second century. Hence, optimal usage of energy source by avoiding any unnecessary power wastage is required, which makes load monitoring and load management an inevitable part of power system management. On-Intrusive Load Monitoring has been an active research area since the mid-1980s. Fig. 1 schematically shows the concept of the NILM. George W. Hart [1] is widely recognized as the founder of NILM with his research at MIT conducted for the Electric Power Research Institute (EPRI). His work was based on a change in steady-state real and reactive power consumption levels. It lacks the nonintrusive monitoring of continuously variable appliances. Leeb *et al.* [2], [3], coined a new technique for monitoring using transient event detection. The transient behavior of a typical electrical load is strongly influenced by the physical task that the load performs. [3] extends the applicability of the NILM to challenging commercial and industrial sites. The key to disaggregation based on the power signatures which are unique for individual devices is explained in [4], [3]. Unlike direct appliance, monitoring approaches, with the advancement in smart metering [5] [6] [7] [8], it is more flexible and convenient to mine smart meter data to generate load models at device level non-intrusively and generalize to all households with smart meter ownership.

2 LOAD SIGNATURES

The early techniques usually disaggregate the loads based on the distinct electrical features of individual appliances called as Power or Load Signatures (PS). From data acquisition point of view, NILM can be categorized

into low-frequency and high-frequency based metering. Low frequency-based metering extracts electrical features like real and reactive powers, and root-mean-square voltage and current. High frequency-based metering allows extracting current harmonics and then performing a transient state analysis where loads are identified by their spectral or wavelet analysis [2]. The most common among them are Real and Reactive power [1], Electric harmonic [9], the Transient pattern at start-up [2], V-I trajectory analysis from voltage and current wave-shapes [10] and others.

Within the non-intrusive signatures, there is a natural dichotomy according to whether information about the appliance state change is continuously present in the load as it operates (steady-state signatures) or only briefly present during times of state transition (transient signatures).

2.1 STEADY STATE SIGNATURES

Hart used the real(P) and reactive(Q) power variations in P-Q plane [1] for detection. But devices may have discrete changes in power consumption, overlapping of loads due to voltage variations, and also many loads may consume same P and Q. In [11], Akbar and Khan use current harmonics as PS leaving linear loads vulnerable, due to their low harmonic contents. Albicki and Cole [12] used slopes and edges as PS, but only suitable for devices with significant spikes in power draw. Lam *et al.* [2] have proposed to employ V-I trajectory curves for labelling different loads but not yet been successfully applied to a NILM system.

2.2 TRANSIENT SIGNATURES

Leeb *et al.* in [2] use concept of spectral envelope (SE) which is a vector of first several coefficients of the short-time Fourier transform (STFT) of the transient current

signal. This method detects many appliances but has to go through rigorous training for each device before the process of monitoring and classification. Patel et al. [13] used electric noise as PS caused by switching of loads in a socket for transient signal, however electrical wiring in the household may be different for different sockets leads to incorrect detection of the same appliance. Yang et al. [14] employed turn-on transient energy feature for detection. However, it requires high sampling rate for capturing the transients (occur for short time).

3 EVENT DETECTION

A typical event-based NILM approach consists broadly of four processes: power measurement, event detection, event classification, and energy estimation. By monitoring the electrical activity in the home (i.e., power measurements), the system attempts to detect when an appliance has changed its state by looking for changes in this signal (event detection) and then attempts to determine which appliance caused this change (classification) in order to track its electric power consumption (energy disaggregation).

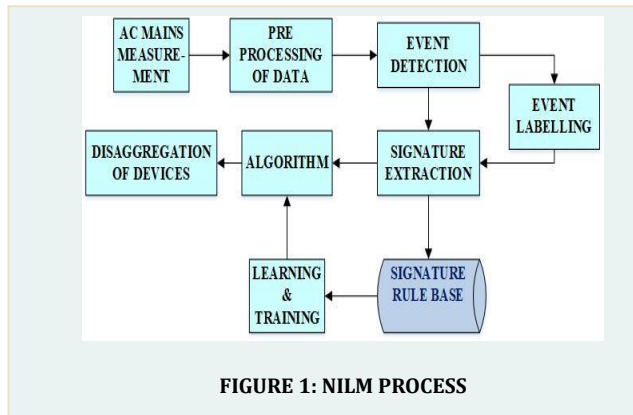

4 CLASSIFICATION TECHNIQUES

It is observed that the outputs (appliances) are correlated to their usage. In this section, different classification techniques are mentioned to converge to a choice of suitable classification techniques which can model the requirement of the classification system.

- Multi-label classification:
 1. Binary Relevance
 2. Label Powerset
 3. The Decision Tree Learner
 4. The Support Vector Machine algorithm
- The K-Nearest Neighbours classifier:
 5. Euclidean Distance
 6. Dynamic Time Warping
 7. Temporal Correlation
- Hidden Markov Model-based classification

5 CHALLENGES

Researchers have been working on the NILM problem for the last two decades. The challenges to a NILM problem is both technical and social.

Technically, it is built on top of the premise that the study of how the variation over time of the global energy consumption of a building can lead to information about the appliances that have advocated these changes. Most of the approaches were based on signal processing at a high sampling rate (1 second typically) to evaluate the appliance load signature and subsequently to use pattern recognition techniques for identification of previously trained classifiers. This requires the installation of a sensor for each appliance within the house and is then naturally restricted by this important system of load monitoring (without speaking about the cost). Also, the cost benefit for the user has to be carefully analysed before developing this kind of solution. The appliance usage being different from one user to the other, the variability of consumption patterns is not compatible with a systematic benefit.

Socially, a major hurdle in the NILM research is the privacy concerns of the user as the appliance usage can be co-related with user behaviour. For example, the time at which the lights are shut down can be assumed to be the sleeping time of the inhabitant.

Finally, a non-intrusive method which works for all the range of appliances within the house is yet to be developed.

6 APPLICATIONS

- From a short-term perspective, load disaggregation provides a detailed 24-hour usage summary of individual loads to help utility clear daily transactions.
- From a long-term perspective, the historical daily usage database of individual loads forms the basis of study on day-ahead load forecasting and usage behaviour.
- Real-time load identification promises the energy balance control in buildings.

REFERENCES

- [1] G. W. Hart, "Nonintrusive appliance load monitoring," *Proc. IEEE*, vol. 80, no. 12, pp. 1870–1891, Dec. 1992.
- [2] S. B. Leeb, S. R. Shaw, and J. L. Kirtley, "Transient event detection in spectral envelope estimates for nonintrusive load monitoring," *IEEE Trans. Power Deliv.*, vol. 10, no. 3, pp. 1200–1210, Jul. 1995.
- [3] H. H. Chang, K. L. Lian, Y. C. Su, and W. J. Lee, "Power-spectrum-based wavelet transform for nonintrusive demand monitoring and load identification," *IEEE Trans. Ind. Appl.*, vol. 50, no. 3, pp. 2081–2089, 2014.
- [4] J. Liang, S. K. K. Ng, G. Kendall, and J. W. M. Cheng, "Load Signature Study 2014; Part II: Disaggregation Framework, Simulation, and Applications," *IEEE Trans. Power Deliv.*, vol. 25, no. 2, pp. 561–569, Apr.

- 2010.
- [5] W. Wichakool, Z. Remscrim, U. A. Orji, and S. B. Leeb, "Smart Metering of Variable Power Loads," *IEEE Trans. Smart Grid*, vol. 6, no. 1, pp. 189–198, Jan. 2015.
- [6] M. Šíra and V. N. Zachovalová, "System for Calibration of Nonintrusive Load Meters With Load Identification Ability," *IEEE Trans. Instrum. Meas.*, vol. 64, no. 6, pp. 1350–1354, Jun. 2015.
- [7] W. Kong, Z. Y. Dong, J. Ma, D. Hill, J. Zhao, and F. Luo, "An Extensible Approach for Non-Intrusive Load Disaggregation with Smart Meter Data," *IEEE Trans. Smart Grid*, vol. PP, no. 99, p. 1, 2017.
- [8] C. Dinesh, B. W. Nettasinghe, R. I. Godaliyadda, M. P. B. Ekanayake, J. Ekanayake, and J. V. Wijayakulasooriya, "Residential Appliance Identification Based on Spectral Information of Low Frequency Smart Meter Measurements," *IEEE Trans. Smart Grid*, vol. 7, no. 6, pp. 2781–2792, Nov. 2016.
- [9] J. T. Chiang, T. Zhang, B. Chen, and Y. C. Hu, "Load disaggregation using harmonic analysis and regularized optimization," in *Proceedings of The 2012 Asia Pacific Signal and Information Processing Association Annual Summit and Conference*, 2012, pp. 1–4.
- [10] T. Hassan, F. Javed, and N. Arshad, "An Empirical Investigation of V-I Trajectory Based Load Signatures for Non-Intrusive Load Monitoring," *IEEE Trans. Smart Grid*, vol. 5, no. 2, pp. 870–878, Mar. 2014.
- [11] M. Akbar and Z. A. Khan, "Modified nonintrusive appliance load monitoring for nonlinear devices," in *INMIC2007 - 11th IEEE International Multitopic Conference*, 2007.
- [12] A. I. Cole and A. Albicki, "Data extraction for effective non-intrusive identification of residential power loads," in *IMTC/98 Conference Proceedings. IEEE Instrumentation and Measurement Technology Conference. Where Instrumentation is Going (Cat. No.98CH36222)*, 1998, vol. 2, pp. 812–815 vol.2.
- [13] S. N. Patel, T. Robertson, J. A. Kientz, M. S. Reynolds, and G. D. Abowd, "At the Flick of a Switch: Detecting and Classifying Unique Electrical Events on the Residential Power Line (Nominated for the Best Paper Award)," in *UbiComp 2007: Ubiquitous Computing: 9th International Conference, UbiComp 2007, Innsbruck, Austria, September 16-19, 2007. Proceedings*, J. Krumm, G. D. Abowd, A. Seneviratne, and T. Strang, Eds. Berlin, Heidelberg: Springer Berlin Heidelberg, 2007, pp. 271–288.
- [14] H.-H. Chang, H.-T. Yang, and C.-L. Lin, "Load Identification in Neural Networks for a Non-intrusive Monitoring of Industrial Electrical Loads," in *Computer Supported Cooperative Work in Design IV: 11th International Conference, CSCWD 2007, Melbourne, Australia, April 26-28, 2007. Revised Selected Papers*, W. Shen, J. Yong, Y. Yang, J.-P. A. Barthès, and J. Luo, Eds. Berlin, Heidelberg: Springer Berlin Heidelberg, 2008, pp. 664–674.

Online monitoring of Power System through Phasor Measurement Unit

Preeti Jain
ECE Department
PDPM-IIITDM, Jabalpur-482005.

Abstract: *The power system is very large, complex and integrated system and is all exposed to the environment. As it is exposed to the environment it is subjected to environmental changes like the wind, rain, lightning, ice loading etc. Apart from these environmental changes, it is also subjected to operational changes like switching, load variation, an outage of the alternator, transmission line, transformer, load shedding, mal-operation of protective devices etc. In addition, there is a large intrusion of the non-linear load in power systems like industrial drives, FACT devices, converter and inverters used in HVDC transmission, SMPS and UPS used with a computer and other electronic gadgets. All these aggravates to power quality issues and results in either small disturbances or large system oscillation and if not controlled in time they may cause system collapse or BLACKOUT of the affected grid. Therefore, there is a need of very stringent, swift and precise approach for online monitoring of Power System. PMUs (Phasor Measurement Unit) through synchronized phasor and frequency estimation of buses voltage provide an effective and powerful method to meet this challenge. In this article, Phasor Measurement Unit, their application in wide area monitoring and issues and challenges in phasor measurement are discussed.*

Keywords: : PMU (Phasor Measurement Unit), synchrophasor, WAMS (Wide Area Monitoring System), SCADA (Supervisory control and data acquisition)..

1 INTRODUCTION

Conventionally, SCADA (Supervisory Controlled and Data Acquisition system) is used for power system monitoring and control. It comprises of RTUs (Remote Terminal Unit) or RTDs (Remote Terminal Devices) which are installed at the remote end in power substation fetching analog data through CTs (Current Transformer) and PTs (Potential Transformer). After processing this data, estimated phasor frames are sent to control centre, through various communication channels.

Communication channels like Fibre optics cables, Microwave link, Ethernet, PLC (Power Line carrier), and the telephone lines can be used for data communication. Since associated delay with fiber optic cable and microwave link is least (approx. 100-150 millisecond) therefore these are normally used.

Conventional SCADA based monitoring is not applicable for WAMS (Wide Area Monitoring System)[1] because its resolution is quite low 2-4 samples per second, therefore it does not provide dynamic and transient state observability. Also, here we get no information regarding phase angle of bus voltage which is a major indicator of system stress.

However, it is very difficult to replace SCADA completely with WAMS as it is currently not possible mainly due to the prohibitive reinforcement and maintenance cost. SCADA and WAMS will coexist and complementarily support the wide-area monitoring and control in electric transmission networks.

2 PHASOR MEASUREMENT UNIT

PMUs (Phasor Measurement Units) are providing a promising future for wide area monitoring by estimating high resolution synchronized phasors. For monitoring and control of power system as well as for planning, load/ generation balance,[2] frequency and ROCOF (Rate of change of Frequency) is also very crucial. Through estimated phasors, this information can also be determined.

The concept of phasor was introduced by Charles Proteus Steinmetz in 1893 in a paper for symmetrical fault analysis of unsymmetrical fault current. Extension of this concept by Dr. Arun G. Phadke and Dr. James S. Thorp at Virginia Tech[3] [4] resulted in an estimation of real-time phasor measurements that are synchronized [1] to an absolute time reference provided by GPS satellites. This led to the invention of Phasor Measurement Unit (PMU) in 1988.

The first commercially available PMUs were manufactured by Macrodyne (Model 1690) in the early 1990s. As of July 2017, more than 2000 PMUs have been deployed in the US.

Different companies, which are manufacturing PMUs, are Virginia Tech lab, Microdyne, ABB, SEL, GE, AMETEK etc. PMUs are strictly made in compliance with IEEE standards C37.118.1,2[5] that are providing compliance standard under steady-state and dynamic condition separately.

PMU is a device that produces synchronized phasor, frequency and rate of change of frequency from analog voltage and current signals obtained from CTs and PTs installed in substations. This information is sent as a set of frames with reporting rate 10-25-50 frames/sec for 50 Hz system and 10-12-15-20-30-60 frames/sec for 60 Hz system. Each frame comprises of voltage and current phasor (3-phases), voltage and current sequence component, frequency and rate of change of frequency, circuit breaker status. This information from different PMUs installed on different buses is send to PDC (Phasor data concentrator). PDCs concentrate this data and further send to higher PDCs and control center, for taking the necessary control action.

PMUs are manufactured for protection and measurement applications. Protection applications require fast response, therefore relatively shorter window length is used for phasor estimation and an anti-aliasing filter are not explicitly used. For measurement application, accuracy is important, therefore relatively longer window length with anti-aliasing filter is explicitly used for phasor estimation.

3 CHALLENGES WITH ALGORITHMS USED

PMUs find wider application for both online and offline monitoring of power system. Offline applications include model validation and post-disturbance analysis. Online application includes wide area monitoring, state estimation, oscillation monitoring, frequency stability monitoring and voltage stability monitoring. If PMU estimations are not accurate then all these applications which rely on PMU data will subsequently be get affected.

Working and operation of PMUs are strictly governed by the algorithm being used with these devices. The input to this algorithm is given from CTs, PTs and time synchronized GPS system which are not accurate under all conditions. Therefore, algorithm used inside PMU

must be highly accurate and precise. Initially focus area of phasor application was protection devices therefore most of the paper published have suggested algorithm for relay protection.

An algorithm based symmetrical component for protecting a transmission line was introduced by Phadke, A.G., Hlibka *et al.* It was very efficient algorithms for computing symmetrical components of three-phase voltages and currents & calculation of positive-sequence voltages and currents. This gave an impetus for the development of modern phasor measurement systems.

A paper [6] published by Phadke, A.G., Thorp, J.S, and Adamiak, M.G identify the importance of positive-sequence voltage and current phasor measurements, and some of the uses of these measurements. This paper can be viewed as the starting point of modern synchronized phasor measurement technology.

Initially, DFT and non-DFT based algorithms were used for phasor and frequency estimation. These include[7] Level crossing, [8]Kalman filtering, [9]Newton algorithm, Adaptive neural network,[10] Recursive least squares, Extended Kalman filtering, Recursive wavelet etc. These were basically non-parametric approaches.

4 FUNDAMENTAL OF FFT BASED APPROACHES

A waveform consists of signals of different frequencies, therefore extracting nominal or fundamental frequency from a given signal in an analysis and then representing it by a phasor is a difficult task. Practically only pure sinusoid can be represented by Phasor and for extracting a single frequency component Fourier transform is used. In discrete domain, this is called discrete Fourier transform (DFT) or the fast Fourier transform (FFT).

For continuous time function $x(t)$ the Fourier transform is given by,

$$X(f) = \int_{-\infty}^{+\infty} x(t) e^{-j2\pi ft} dt \quad (1)$$

To have sampled value of function, impulse function $\delta(t)$ is used,

$$x(t) = \int_{-\infty}^{+\infty} \delta(t - t_0) x(t) dt$$

After getting sampled data signal of given signal $x(t)$, its Fourier transform is determined in the frequency domain at discrete steps.

In non-recursive approach, phasor calculation is a continuous process, as new data samples are acquired new phasor will be updated. When the N th sample has obtained the calculations for the new data window would be repeated, that begins at $n = 1$ and ends at $n = N$. Therefore the $(N-1)$ th & N th value of estimated phasors are given by,

$$X^{N-1} = \frac{\sqrt{2}}{N} \sum_{n=0}^{N-1} x_n [\cos(n\theta) - j\sin(n\theta)]$$

$$X^N = \frac{\sqrt{2}}{N} x_{n+1} \sum_{n=0}^{N-1} [\cos(n\theta) - j\sin(n\theta)]$$

where, N is the number of samples per cycle.

In recursive approach, to determine the value of the succeeding phasor, only phasor estimation of a new sample with a recursive update is required. Hence the $(N-1)$ th and (N) th phasors here are given by,

$$X^{N-1} = \frac{\sqrt{2}}{N} \sum_{n=0}^{N-1} x_n e^{-jn\theta}$$

$$X^N = \frac{\sqrt{2}}{N} \sum_{n=0}^{N-1} x_{n+1} e^{-jn\theta}$$

Recursive and non-recursive phasor estimation algorithms are more accurate as compared to FFT, but recursive algorithm is computationally fast. Therefore it is a preferable choice in commercial PMUs.

Frequency tracking technique by [7] C. T. Nguyen and K. Srinivasan, based on level crossing was developed. This technique was simple but insensitive to noise, the presence of DC component & harmonics in the signal.

Kalman filtering [8] based fast relaying technique was developed by [11] H. G. Wood, N. G. Johnson, and M. S. Sachdev. It was good for noise rejection but were insensitive to harmonics.

DFT and non-DFT based algorithm being accurate but computationally slow. Most of the presented algorithms consider a static model for the phasor whose amplitude, phase and frequency are constant in an observation window. The inability of these algorithms in tracking significant changes and large frequency excursions led to the introduction of dynamic phasor estimation methods.

[12] Sadeh Vejdani, Majid Sanaye-Pasand, and P. Malik proposed dynamic phasor estimation technique. This method uses the signal model under dynamic conditions, linearize them by using Taylor's series expansion and estimate the phasor using the least squares technique. Frequency and its rate of change are also calculated using adjacent phasors with minimum complexity.

Least square approach gives the overall solution by minimizing the sum of the squares of the errors made in the result of every single equation i.e.,

$$\sum_{i=1}^{n2} e[i]^2$$

Let desired output sequence be $d[n]$, input sequence $x[n]$, filter coefficient $h[n]$, We have to design $h[n]$ to derive desired output

$$d[n] = \sum_{k=0}^{M-1} h[k]x[n-k] + e[n] \leftarrow \text{error}$$

For given $x[n]$, $d[n]$ we have to find $h[n]$ to minimize 'e'

$$\begin{pmatrix} e[0] \\ \vdots \\ e[n-1] \end{pmatrix} = \begin{pmatrix} d[0] \\ \vdots \\ d[n-1] \end{pmatrix} - \begin{pmatrix} x[0] & x[-1] & x[-2] & \dots \\ x[1] & x[0] & x[-1] & \dots \\ x[2] & x[1] & x[0] & \dots \\ \vdots & \vdots & \vdots & \vdots \\ x[N-1] & x[N-2] & \dots & x[N-m] \end{pmatrix} \begin{pmatrix} h[0] \\ \vdots \\ h[m-1] \end{pmatrix}$$

It is standard approach in regression analysis to approx. the solution of an overdetermined system.

In parametric approach another effective and powerful method is [13] Matrix pencil method. Matrix Pencil Method being more robust to noise in the sampled data has a lower variance of the estimates of the parameters of interest than a polynomial-type method like Prony's method and is also computationally more efficient. The method of approximating a function by a sum of complex exponentials was first developed by Prony in 1795, and further developed in

The basic difference between the polynomial and matrix pencil method is that the "polynomial" method is a two-step process in finding the poles, z . For a

Some PMU Measurement Test Results

Multiple PMU test results from Texas A&M University

PMU	Class	Steady State Test									Dynamic State Test													
		Magnitude Variation			Phase Angle Variation			Frequency Variation			Measurement Bandwidth			Frequency Ramp			Step Change							
		TV	F	RF	TV	F	RF	TV	F	RF	TV	F	RF	TV	F	RF	R	D	M					
PMU A	P	S	S	S	S	S	S	S	S	S	S	S	S	S	F	S	S	F	F	F	F	F	F	F
	M	S	S	S	S	S	S	S	S	S	S	S	S	S	F	S	S	F	F	F	S	F	F	F
PMU A-1	P	S	S	S	S	S	S	S	S	S	S	S	S	S	F	S	S	F	F	F	S	S	F	F
	M	S	S	S	S	S	S	S	S	S	S	S	S	S	F	S	S	F	F	F	S	S	F	F
PMU B	P	S	S	S	S	S	S	S	S	S	S	S	S	S	F	S	S	F	F	F	S	S	F	F
	M	S	S	S	S	S	S	S	S	S	S	S	S	S	F	S	S	F	F	F	S	S	F	F
PMU C	P	S	S	S	S	S	S	S	S	S	S	S	S	S	F	S	S	F	F	F	S	S	F	F
	M	S	S	S	S	S	S	S	S	S	S	S	S	S	F	S	S	F	F	F	S	S	F	F
PMU D	P	S	S	S	S	S	S	S	S	S	S	S	S	S	F	S	S	F	F	F	S	S	F	F
	M	S	S	S	S	S	S	S	S	S	S	S	S	S	F	S	S	F	F	F	S	S	F	F
PMU E	P	S	S	S	S	S	S	S	S	S	S	S	S	S	F	S	S	F	F	F	S	S	F	F
	M	S	S	S	S	S	S	S	S	S	S	S	S	S	F	S	S	F	F	F	S	S	F	F
PMU F	P	S	S	S	S	S	S	S	S	S	S	S	S	S	F	S	S	F	F	F	S	S	F	F
	M	S	S	S	S	S	S	S	S	S	S	S	S	S	F	S	S	F	F	F	S	S	F	F
PMU G	P	S	S	S	S	S	S	S	S	S	S	S	S	S	F	S	S	F	F	F	S	S	F	F
	M	S	S	S	S	S	S	S	S	S	S	S	S	S	F	S	S	F	F	F	S	S	F	F
PMU H	P	S	S	S	S	S	S	S	S	S	S	S	S	S	F	S	S	F	F	F	S	S	F	F
	M	S	S	S	S	S	S	S	S	S	S	S	S	S	F	S	S	F	F	F	S	S	F	F

S: satisfied, F: failure, P: class P, M: class M, TVE: total vector error, FE: frequency error, RFE: rate of change of frequency error, RT: response time, DT: delay time, MO: maximum over/under shoot.

Source: J. Ren, M. Kezunovic, and Y. Guan, "Verifying Interoperability and Application Performance of PMUs and PMU-enabled IEDs", IEEE PES GM 2012

polynomial method, one needs to solve a matrix equation for the coefficients of a polynomial, whose roots provide z. Whereas the "matrix pencil" approach is a one-step process. The poles z, are found as the solution of a generalized eigenvalue problem Hence, there is no practical limitation on the number of poles, M, that can be obtained by this method.

In contrast, for a polynomial method it is difficult to find roots of a polynomial for, say, M greater than 50. The Matrix Pencil approach is not only more computationally efficient, but it also has better statistical properties for the estimates of z, than the "polynomial" method. Therefore, this approach is providing an alternative to researchers for phasor and frequency estimation.

5 PERFORMANCE EVALUATION

Performance evaluation of different suggested algorithm is being done on the basis of certain parameters which governs the overall efficiency of the algorithm.

These parameters are frequency, the rate of change of frequency (ROCOF), the rate of change of frequency error (RFE) and total vector error (TVE). These are evaluated from estimated phasor under different test condition such as off-nominal frequency, in presence of harmonics, in presence of noise, frequency ramp etc., as per IEEE standards C37.118.1,2.

TVE (total vector error) is an expression of the difference between a "perfect" sample of a theoretical synchrophasor and the estimate given by the unit under test at the same instant of time. The value is normalized and expressed as per unit of the theoretical phasor. As per IEEE standard the maximum value of TVE should not be more than 1%.

$$TVE(n) = \sqrt{\frac{(\hat{X}_r(n) - X_r(n))^2 + (\hat{X}_i(n) - X_i(n))^2}{(X_r(n))^2 + (X_i(n))^2}}$$

Where, $\hat{X}_r(n)$ and $\hat{X}_i(n)$ are the sequences of estimates given by the unit under test, $X_r(n)$ and $X_i(n)$ are the sequences of theoretical values of the input signal at the instants of time (n).

6 CONCLUSION

For accurate phasor and frequency estimation modelling of signal, presence of noise and harmonics are very crucial. Most of the researcher have consider separate model for pre and post fault conditions and then their performance is evaluated in presence of noise and harmonics.

While evaluating the performance number of samples per cycle, length of window does affect the estimation accuracy and computation time. Some of the suggested algorithms are giving satisfactory results under steady state condition while other are giving under dynamic condition but none of the single algorithm is giving satisfactory performance under both steady state and dynamic condition. Also, most of the algorithm are giving accurate estimation under steady state condition only. Since power system is never steady & always remain in a state of dynamics therefore, there is need of an algorithm whose accuracy is in compliance with IEEE standards for both steady state and dynamic conditions.

REFERENCES

- [1] J. De La Ree, V. Centeno, J. S. Thorp, and A. G. Phadke, "Synchronized phasor measurement applications in power systems," IEEE Trans. Smart Grid, vol. 1, no. 1, pp. 20-27, 2010.
- [2] A. G. Phadke and S. Dunlap, "Frequency Tracking in Power Networks in the Presence of Harmonics," IEEE

- Trans. Power Deliv., vol. 8, no. 2, pp. 480–486, 1993.
- [3] A. G. Phadke and J. S. Thorp, "History and applications of phasor measurements," 2006 IEEE PES Power Syst. Conf. Expo. PSCE 2006 - Proc., pp. 331–335, 2006.
- [4] A. G. Phadke and J. S. Thorp, Synchronized Phasor Measurements and Their Applications. 2008.
- [5] I. Standard, C. With, and C. Amendment, "Synchrophasor Measurements Under the IEEE Standard C37.118.1-2011 With Amendment C37.118.1a," vol. 30, no. 3, pp. 1514–1522, 2015.
- [6] J. S. T. Arun G. Phadke, "Synchronized Phasor Measurements and Their Applications," no. february, pp. 78–80, 2009.
- [7] S. berand C T. Nguyen and K. Srinivasan, "A New Technique for Rapid Tracking of Frequency Deviations Based on Level Crossings," no. August, p. 1984, 1984.
- [8] L. Wang, "Frequency responses of phasor-based microprocessor relaying algorithms," IEEE Trans. Power Deliv., vol. 14, no. 1, pp. 98–105, 1999.
- [9] P. K. Dash, K. K.r., and R. K. Patnaik, "Dynamic phasor and frequency estimation of time-varying power system signals," Int. J. Electr. Power Energy Syst., vol. 44, no. 1, pp. 971–980, 2013.
- [10] M. Mirsalim and A. Ashrafian, "On-line recursive method of phasor and frequency estimation for power system monitoring and relaying," IET Gener. Transm. Distrib., vol. 10, no. 8, pp. 2002–2011, 2016.
- [11] R. Channels, "SYNCHRONIZED SAMPLING AND PHASOR MEASUREMENTS FOR Prepared by Working Group H-7 of the Relaying Channels," vol. 9, no. 1, 1994.
- [12] S. Vejdani, M. Sanaye-Pasand, and O. P. Malik, "Accurate Dynamic Phasor Estimation Based on the Signal Model Under Off-Nominal Frequency and Oscillations," IEEE Trans. Smart Grid, vol. 8, no. 2, pp. 708–719, 2017.
- [13] T. K. Sarkar and O. Pereira, "Using the Matrix Pencil Method to Estimate the Parameters of a Sum of Complex Exponentials," vol. 37, no. 1, 1995.

On Fractional Order $I^\lambda D^\mu$ Controllers

Rishika Trivedi
ECE Department
PDPM-IIITDM, Jabalpur-482005.

Abstract: Fractional order PID (FOPID) controller is a generalisation of integer order PID controller. The effect of two additional parameters λ (fractional order of integral) and μ (fractional order of differentiator) has been observed. The different orders μ are taken in literature to effectively demonstrate the geometrical and physical interpretation of fractional order derivative. It has been shown that the value of α has significant effect in system behaviour.

Keywords: Fractional order systems (FOS), fractional order differentiator and integrator.

1 INTRODUCTION

In past few year, fractional order PID (FOPID) controllers have received a substantial attention in terms of academic and industrial applications. Indeed, FOPID is more flexible in the controller design as compared to standard PID controllers, because of availability of five parameters to tune (rather than three). Though, it increases the complexity in tuning, it also increases the robustness and performance of the system. In order to deal with this problem, literatures have proposed various methods for the design of a FOPID controller. Podlubny proposed FOPID controller and demonstrated the better response of such controller, as compared to classical PID controller for fractional order systems [1][2].

Many real time dynamic processes can be efficiently modelled using fractional order systems more adequately than integer order processes [3]. It has been experimentally demonstrated that the charging and discharging of lossy capacitors for example, follows inherently fractional order dynamics. The flow of fluid in a porous media, the conduction of heat in a semi-infinite slab, voltage-current relation in a semi-infinite transmission line, non-Fickian diffusion, etc. are all such examples where the governing equations can be modeled more accurately using fractional order differential or integral operators.

2 OVERVIEW OF FRACTIONAL ORDER CONTROLLER

Fractional order controllers have upright controlling capability on dynamic characteristics of the

system and less sensitive to parametric variations, which are considered as advantages over classical PID controller because of fractional component of the integer order PID controller [4]. The transfer function of such a controller has the following form:

$$C(s) = k_p + \frac{k_i}{s^\lambda} + k_d s^\mu \quad (1)$$

Fractional PID controllers are considered as a generalize model of integer PID such that:

- Considering, $\lambda = 1$ and $\mu = 1$, gives an integer order PID.
- Considering, $\lambda = 1$ and $\mu = 0$, gives a Proportional-integral controller.
- Considering, $\lambda = 0$ and $\mu = 1$, gives a Proportional-differential controller.
- Considering, $\lambda = 0$ and $\mu = 0$, gives a Proportional controller.

It can be shown graphically as in Figure1 and it is called FOPID control space[5].

3 PRELIMINARIES AND DEFINITIONS

Various definitions for implementing fractional order integro-differential equations [6]. Fractional calculus is a generalization of integration and differentiation to non-integer order fundamental operator ${}_a D_a^r$, where a and t are the limits of the operation and $r \in \mathbb{R}$. The continuous integro-differential operator is defined as:

$${}_a D_\alpha^t = \begin{cases} \frac{d^r}{dt^r} & : r > 0 \\ 1 & : r = 0 \\ \int_a^t (d\tau)^{-r} & : r < 0 \end{cases} \quad (1)$$

The three equivalent definitions most frequently used for the general fractional differintegral are the Grunwald-Letnikov (GL) definition, the Riemann-Liouville (RL) and the Caputo definition [2][7]. The GL is defined by,

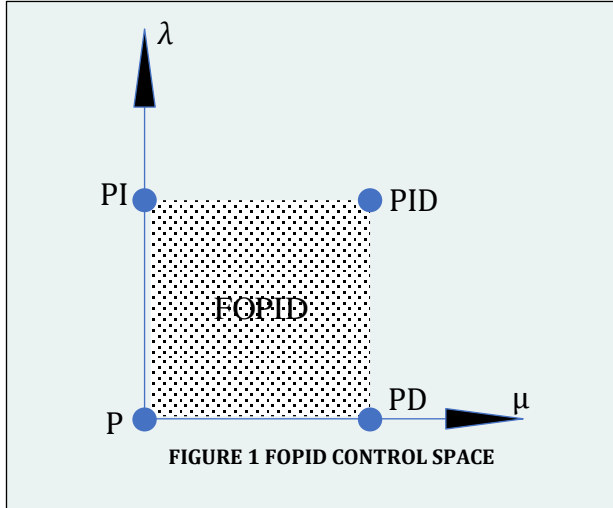

$${}_a D_\alpha^t = \lim_{h \rightarrow 0} h^{-\alpha} \sum_{j=0}^{\lfloor \frac{t-a}{h} \rfloor} (-1)^j \binom{\alpha}{j} f(t-jh) \quad (2)$$

where, $[\cdot]$ represents the integer order. The RL is defined as

$${}_a D_\alpha^t = \frac{1}{\Gamma(n-\alpha)} \frac{d^n}{dt^n} \int_a^t \frac{f(\tau)}{(t-\tau)^{\alpha-n+1}} d\tau \quad (3)$$

where $n-1 < \alpha < n$ & $\Gamma[\cdot]$ is Euler's gamma function.

Under zero initial conditions, the Laplace transform of the RL definition shown in eq. (2) is given by

$$\mathcal{E}\{{}_a D_t^{\pm\alpha} f(t)\} = s^{\pm\alpha} F(s) \quad (4)$$

It is difficult to implement s^ν practically. Therefore, it is approximated using an ordinary (integer order) transfer function. Outstaloup has introduced one of the most commonly used approximation [18] which makes use of recursive distribution of poles and zeros. The transfer function of the approximation is given by:

$$s^\nu \approx s_{[w_b, w_h]}^\nu = K \prod_{k=-N}^N \frac{s + \omega'_k}{s + \omega_k} \quad (5)$$

This approximation is defined for the frequency range $[\omega_b, \omega_h]$ and the order of approximation is $2N+1$. In eq. (6), the gain K , zeroes ω'_k and poles ω_k are obtained as follows:

$$K = \omega_h^\nu$$

$$\omega'_k = \omega_b \left(\frac{\omega_h}{\omega_b} \right)^{\left(k+N+\frac{1}{2}(1-\nu) \right) / (2N+1)} \quad (6)$$

$$\omega_k = \omega_b \left(\frac{\omega_h}{\omega_b} \right)^{\left(k+N+\frac{1}{2}(1+\nu) \right) / (2N+1)}$$

The literatures have proposed some approximation methods to implement fractional-order integro-differential operators, such as continuous fractional expansion [8], Carlson's method [9] and Matsuda's method [10]. The toolboxes for modelling FOPID is also provided in the literature. As proposed by Aleksei *et. al.*, FOMCON Toolbox can be used for Modeling and Control Fractional-Order systems in MATLAB [11]. Senol *et. al.* proposed a toolbox for advance control education [12]. CRONE toolbox was presented by Oustaloup *et. al.* for fractional control application in MATLAB [13]. A toolbox for PID controller design on internet was proposed by Martin *et. al.* [14].

4 GEOMETRICAL INTERPRETATION OF FRACTIONAL DERIVATIVE

In a modest way, geometrical and physical interpretations of integer order derivative and integral are defined [15]. The fractional order derivative and fractional order integral are thus far not well recognized. A simple interpretation of fractional order derivative for the applications of the subject is presented. The fractional order derivatives can be enumerated as:

$$D^\alpha [x^\beta] = \frac{\Gamma(\beta+1)}{\Gamma(\beta+1-\alpha)} x^{\alpha-\beta}, \quad (7)$$

where α is the order of derivative and $0 < \alpha < 1$. By using the formula given in (8) and the linearity property of fractional derivative, the values of fractional derivative for $f(x) = x^3$ and $g(x) = x^4 + x^3$ at $x = 2$ were computed by the authors of [15] and shown in Table 1 and Table 2, respectively. The value of $D^{1.0}[f(x)] = 12.00$ for $f(x) = x^3$ at P (2, 8). A triangle is formed by drawing a tangent at P (2, 8) passing through the X-axis at A1, and the perpendicular drawn from P (2,

Table 2 Details of $f(x)$ [7]

Fractional order derivative	Fractional derivative values at $x = 2$ $m = \tan \mu$	$\mu = \tan^{-1}m$ (in radian)	Area of triangle (Δ)
$D^{0.1}[f(x)]$	$m_{0.1}=8.4512$	$\theta_{0.1}=1.113$	$\Delta PA_{0.1}B = 3.7865$
$D^{0.2}[f(x)]$	$m_{0.2}=8.9018$	$\theta_{0.2}=1.4589$	$\Delta PA_{0.2}B = 3.5948$
$D^{0.3}[f(x)]$	$m_{0.3}=9.3482$	$\theta_{0.3}=1.4642$	$\Delta PA_{0.3}B = 3.4231$
$D^{0.4}[f(x)]$	$m_{0.4}=9.7866$	$\theta_{0.4}=1.4690$	$\Delta PA_{0.4}B = 3.2698$
$D^{0.5}[f(x)]$	$m_{0.5}=10.2129$	$\theta_{0.5}=1.4732$	$\Delta PA_{0.5}B = 3.1333$
$D^{0.6}[f(x)]$	$m_{0.6}=10.6226$	$\theta_{0.6}=1.4769$	$\Delta PA_{0.6}B = 3.0124$
$D^{0.7}[f(x)]$	$m_{0.7}=11.0111$	$\theta_{0.7}=1.4802$	$\Delta PA_{0.7}B = 2.9062$
$D^{0.8}[f(x)]$	$m_{0.8}=11.3734$	$\theta_{0.8}=1.4831$	$\Delta PA_{0.8}B = 2.8136$
$D^{0.9}[f(x)]$	$m_{0.9}=11.7044$	$\theta_{0.9}=1.4856$	$\Delta PA_{0.9}B = 2.7339$
$D^{1.0}[f(x)]$	$m_{1.0}=12.0000$	$\theta_{1.0}=1.4877$	$\Delta PA_{1.0}B = 2.6667$

Table 2 Details of $g(x)$ [7]

Fractional order derivative	Fractional derivative values at $x = 2$ $m = \tan \theta$	$\theta = \tan^{-1}m$ (in radian)	Area of triangle (Δ)
$D^{0.1}[g(x)]$	$m_{0.1}=25.787$	$\theta_{0.1}=1.5320$	$\Delta PA_{0.1}B = 11.1684$
$D^{0.2}[g(x)]$	$m_{0.2}=27.642$	$\theta_{0.2}=1.5346$	$\Delta PA_{0.2}B = 10.4188$
$D^{0.3}[g(x)]$	$m_{0.3}=29.561$	$\theta_{0.3}=1.5370$	$\Delta PA_{0.3}B = 9.7427$
$D^{0.4}[g(x)]$	$m_{0.4}=31.535$	$\theta_{0.4}=1.5391$	$\Delta PA_{0.4}B = 9.1328$
$D^{0.5}[g(x)]$	$m_{0.5}=33.557$	$\theta_{0.5}=1.5410$	$\Delta PA_{0.5}B = 8.5825$
$D^{0.6}[g(x)]$	$m_{0.6}=35.617$	$\theta_{0.6}=1.5427$	$\Delta PA_{0.6}B = 8.0860$
$D^{0.7}[g(x)]$	$m_{0.7}=37.705$	$\theta_{0.7}=1.5443$	$\Delta PA_{0.7}B = 7.6383$
$D^{0.8}[g(x)]$	$m_{0.8}=39.807$	$\theta_{0.8}=1.5457$	$\Delta PA_{0.8}B = 7.2349$
$D^{0.9}[g(x)]$	$m_{0.9}=41.911$	$\theta_{0.9}=1.5469$	$\Delta PA_{0.9}B = 6.8718$
$D^{1.0}[g(x)]$	$m_{1.0}=44.000$	$\theta_{1.0}=1.5481$	$\Delta PA_{1.0}B = 6.5455$

8) to X-axes at B (2, 0). The area of the triangle formed $\Delta PA_1B = 2.6667$. Similarly, area of triangle is computed for the function $g(x)$.

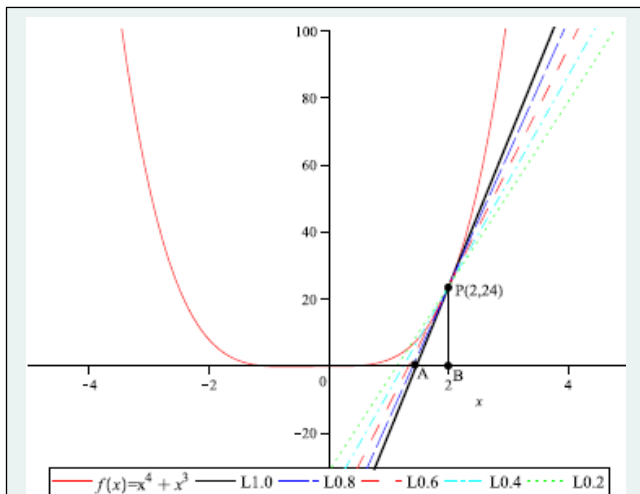

FIGURE 2. GRAPH OF THE FUNCTION $F(X) = x^4 + x^3$ WITH TRIANGLES FORMED WITH FRACTIONAL ORDER DERIVATIVES [15]

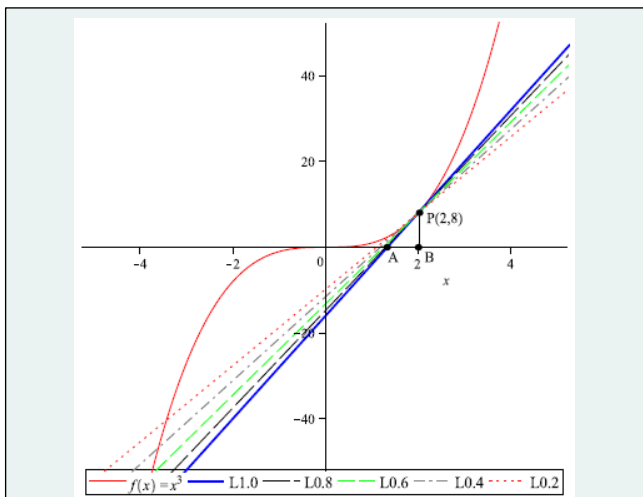

FIGURE 3. GRAPH OF THE FUNCTION $F(X) = X^3$ WITH TRIANGLES FORMED WITH FRACTIONAL ORDER DERIVATIVES [15].

It has been interpreted by the authors of [15], using Tables 1, Table 2, Figure2 and Figure 3, that as the value of fractional order derivative increases, the area of triangle formed decreases, also as the value of fractional order derivative decreases, the area of triangle

increases. Hence, it can be concluded that fractional order derivative values are inversely proportional to the areas of triangles. Therefore,

$$D^\alpha [f(x)] \propto \frac{1}{\Delta} \quad (8)$$

$$D^\alpha [g(x)] \propto \frac{1}{\Delta} \quad (9)$$

5 CONCLUSION

To conclude, the product of values of fractional order derivative with the correspondent area of the triangle is constant [15]. So, the fractional derivative produces the change in the area of the triangle formed drawing a tangent to the curve at a particular point, the perpendicular line drawn through this point and the X-axes with respect to fractional gradient line. The change of area is a physical property, thus fractional derivatives can be used to measure the changes in temperature, pressure, gradient, divergence and curl[15].

REFERENCES

- [1] I. Podlubny, L. Dorcak, and I. Kostial, "On Fractional Derivatives, Fractional-Order Dynamic Systems and PID Controllers," *Proc. 36th Conf. Decis. Control*, no. December, pp. 4985–4990, 1997.
- [2] I. Podlubny, "Fractional-order systems and PI/sup /spl lambda//D/sup /spl mu//-controllers," *IEEE Trans. Automat. Contr.*, vol. 44, no. 1, pp. 208–214, 1999.
- [3] S. Das and I. Pan, "Fractional order signal processing: Introductory concepts and applications," *SpringerBriefs Appl. Sci. Technol.*, no. 9783642231162, pp. 13–31, 2012.
- [4] Khanra Munmun, Goswami Bhaswati, and Biswas Karabi, "A Comprehensive Study on Fractional Order Differentiator and Integrator.," *Xxxii Natl. Syst. Conf. Nsc 2008.*, pp. 677–683, 2008.
- [5] D. Valeio and J. Costa, "Tuning of fractional PID controllers with Ziegler–Nichols-type rules," *Signal Processing*, vol. 86, pp. 2771–2784, 2006.
- [6] R. Trivedi, P. K. Padhy, "Design of Fractional PI^{lambda}D^{mu} Controller via Modified Firefly Algorithm," vol. 0, no. 5.
- [7] R. Caponetto, G. Dongola, L. Fortuna, and I. Petráš, "Fractional Order Systems," vol. 72, WORLD SCIENTIFIC, 2010.
- [8] Y. Chen, B. M. Vinagre, and I. Podlubny, "Continued Fraction Expansion Approaches to Discretizing Fractional Order Derivatives?an Expository Review," *Nonlinear Dyn.*, vol. 38, no. 1–4, pp. 155–170, Dec. 2004.
- [9] G. Carlson and C. Halijak, "Approximation of Fractional Capacitors(1/s)^(1/n)by a Regular Newton Process," *IEEE Trans. Circuit Theory*, vol. 11, no. 2, pp. 210–213, 1964.
- [10] K. Matsuda and H. Fujii, "H(infinity) optimized wave-absorbing control - Analytical and experimental results," *J. Guid. Control. Dyn.*, vol. 16, no. 6, pp. 1146–1153, Nov. 1993.
- [11] A. Tepljakov, E. Petlenkov, and J. Belikov, "FOMCON : Fractional-Order Modeling and Control Toolbox for MATLAB," no. 4, 2011.
- [12] B. Senol, C. Yeroglu, and M. Erturkler, "Development of a User Friendly Toolbox for Advanced Control Education."
- [13] A. Oustaloup, P. Melchior, P. Lanusse, O. Cois, and F. Dancla, "The CRONE toolbox for Matlab," in *CACSD. Conference Proceedings. IEEE International Symposium on Computer-Aided Control System Design (Cat. No.00TH8537)*, pp. 190–195.
- [14] Č. Martin and S. Miloš, "PID controller design on Internet: www.PIDlab.com."
- [15] M. H. Tavassoli, A. Tavassoli, and M. R. O. Rahimi, "The geometric and physical interpretation of fractional order derivatives of polynomial functions," vol. 15, 2013.

FUZZY LOGIC: An Ultimate Control Approach

Roshan Bharti
ECE Department
PDPM-IIITDM, Jabalpur-482005.

Abstract: *This article describes about fuzzy logic, its advantage and application in various field & research area. The Fuzzy logic controller and its main parts such as Fuzzification, fuzzy rule base, fuzzy inference system, defuzzification also described in this article.*

Keywords: Fuzzy Logic, Fuzzy Logic Controller, application and advantage of fuzzy logic

1 INTRODUCTION

Nowadays computational intelligence (CI) plays vital role in human life. Day by day, everything is going to be smart and making human life easier. Computational intelligence is a set of biological and linguistic computational tools and methodologies to address complex and challenging real-world problems to which traditional approaches may not be very effective. Major constituents of CI are neural networks, evolutionary algorithm, fuzzy systems and hybrid intelligent system. In past few decade, Fuzzy Logic gains more popularity by its successful application in various field.

Fuzzy logic is much more general than traditional logical system. It is the way human brain works and we can mimic this in machines so they with perform somewhat like humans and in all cases guided by IF-Then rules stated in human language. As the complexity of system increases, it becomes more difficult and eventually impossible to make a precise statement about its behaviour, eventually arriving at a point of complexity where the fuzzy logic method born humans is the only way to get at the problem.

In bivalent logic, BL, truth is bivalent, implying that every proposition is either true or false, with no degrees of truth allowed. In multivalent logic, ML, truth is a matter of degree. In fuzzy logic, FL, everything is, or is allowed to be, to be partial, i.e., a matter of degree, everything is, or is allowed to be imprecise (approximate), everything is, or is allowed to be granular (linguistic), and everything is, or is allowed to be perception based.

The logical control approach is not new thing it has very old history. Here is the little historical background

of fuzzy logic is given. Classical logic of Aristotle proposed in 400 BC: Law of Bivalence which has been correct for more than 2000 years, in every proposition is either true or false (no intermediate). Jan Lukasiewics proposed three valued logics in 1900: True, False and possible. Lofti A. Zedah proposed a multivalued logic popularly known as Fuzzy logic[1]. L.A Zedah claimed that many sets in the world surrounding us are defined by a non-distinct boundary. S. Hacck published a paper in 1979 titled "Do we need fuzzy logic"[2]. Smarandache proposed a Neutrosophic logic in 1998[3], it not gained importance as being a trivalent logic.

Fuzzy sets, linguistic variables, and possibility distributions are three core concepts in fuzzy logic. A fuzzy set is a generalization to classical set to allow objects to take partial membership in vague concepts (i.e., fuzzy sets). The degree an object belongs to a fuzzy set, which is a real number between 0 and 1, is called the membership value in the set. The meaning of a fuzzy set is thus characterized by a *membership function* that maps elements of a universe of discourse to their corresponding membership values. The membership function of a fuzzy set A is denoted as m_A . In addition to membership functions, a fuzzy set is also associated with a linguistically meaningful term (e.g., "healthy" family). Associating a fuzzy set to a linguistic term offers two important benefits. First, the association makes it easier for human experts to express their knowledge using the linguistic terms. Second, the knowledge expressed using linguistic terms is easily comprehensible. This benefit often results in significant savings in the cost of designing, modifying and maintaining a fuzzy logic system.

2 FUZZY LOGIC CONTROLLER

Professor Lofti A Zadeh presented fuzzy logic not as a control methodology but as a way of processing data by allowing partial set membership rather than crisp set membership or non-membership. The first fuzzy logic controller was made by E.H Mamdani in 1974[4] for a steam engine. The structure of fuzzy logic controller is shown in Figure 1. It mainly consists of four parts- Fuzzification, Fuzzy IF-Then Rule Base, fuzzy Inference Engine, and Defuzzification.

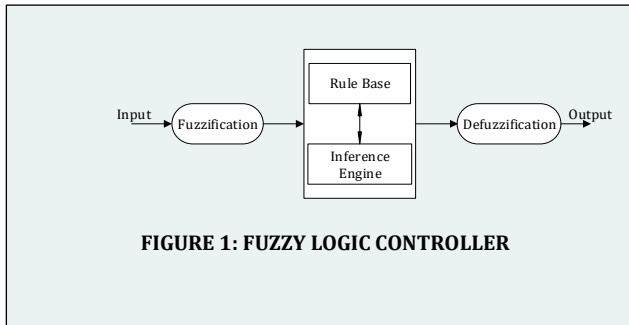

FIGURE 1: FUZZY LOGIC CONTROLLER

2.1 FUZZIFICATION

Fuzzification is supposed to convert the analog inputs into sets of fuzzy variables. For each analog input, several fuzzy variables are generated with values between 0 and 1. The number of fuzzy variables depends on the number of membership functions in fuzzification process. Various types of membership functions can be used for conversion, such as triangular, trapezoidal, Gaussian, sigmoidal, generalized bell, z-shaped, left-right membership function etc. One may consider using the combination of them and different types of membership functions result in different accuracies.

2.2 FUZZY RULE-BASE

A fuzzy if-then rule associates a *condition* about linguistic variables to a *conclusion*. From a knowledge representation view point, a fuzzy if-then rule is a scheme for capturing knowledge that involves imprecision. The main feature of reasoning using these rules (i.e., fuzzy rule-based reasoning) is its *partial matching* capability, which enables an inference to be made from a fuzzy rule even when the rule's condition is only partially satisfied. The degree the input data matches the condition of a rule is combined with the consequent (i.e., "then" part) of the rule to form a conclusion inferred by the fuzzy rule. The higher is the matching degree, the closer is the inferred conclusion to the rule's consequence.

There are two types of fuzzy rules[5]: 1) *fuzzy mapping rules*, and 2) *fuzzy implication rules*. A fuzzy mapping rule describes a functional mapping relationship between inputs and an output using linguistic terms, while a fuzzy implication rule describes a generalized logic implication relationship between two logic formula involving linguistic variables. The foundation of fuzzy mapping rule is fuzzy graph, while the foundation of fuzzy implication rule is a generalization to two-valued logic. The inference of fuzzy mapping rules involves a set of rules whose antecedent conditions form a fuzzy partition of the input space. We call such a collection of fuzzy mapping rules a *fuzzy model*. The inference of fuzzy implication rules are performed individually. Consequently, fuzzy mapping rules are designed as a group, whereas fuzzy implication rules are designed individually.

The distinction between fuzzy implication rules and fuzzy mapping rules has not been clear in the literature. Until early 1990s, fuzzy rules used in control systems have been viewed as a special kind of fuzzy implication rule. However, it is difficult to explain the use of conjunction operator in forming the "fuzzy implication relation" of rules and the use of fuzzy disjunction in aggregating the conclusion of rules. This difficulty gradually leads to the crystallization of the fundamental differences between the two types of rules.

2.3 FUZZY INFERENCE SYSTEMS

Fuzzy inference (reasoning) is the actual process of mapping from a given input to an output using fuzzy logic. The process involves all the three pieces i.e., membership function, fuzzy logic operators and If-Then rule. It is a nonlinear mapping that derives its output based on fuzzy reasoning and a set of fuzzy if-then rules. The domain and range of the mapping could be fuzzy sets or points in a multidimensional space. The fuzzy Inference system (FIS) is also known as fuzzy models, fuzzy associated memory, fuzzy-rule-based systems, and fuzzy expert systems. FIS converts fuzzy input using If-Then type fuzzy rules to the fuzzy output.

There are three fuzzy Inference systems: - Mamdani fuzzy inference, TSK inference model and Tsukamoto inference model. The difference between there inference models are as follows.

- 1) In Mamdani model premise (If part) is fuzzy set and consequent (Then part) is also fuzzy set.
- 2) In TSK model premise in fuzzy set and consequent is crisp.

TABLE 1: RESEARCH AREAS IN FUZY LOGIC AS REPORTED IEEE 2001[6]

Research and Development Area	Main Topics
Fuzzy Mathematics	Foundations of Fuzzy Logic, appropriate reasoning, evolutionary computation, Identification and learning algorithms, rule base optimization.
Control Systems	Fuzzy control theory and applications, process and environmental control, stability criterions issues, multilevel-supervisory control
Pattern Recognition and Image Processing	Supervised and Unsupervised learning, classifiers design and integration, signal/image processing and analysis, computer vision, multimedia applications
Soft Computing and Hybrid Systems	Intelligent information systems, database Systems, data mining intelligent systems, reliability engineering, Neuro-Fuzzy systems, Internet computing, networks traffic modelling and control.
Electronic Systems	Fuzzy hardware implementation and embedded applications.
Robotics and Automation	Fuzzy Logic in robotics, industrial automation and other industrial applications

TABLE 2: SOME SUCCESSFUL FUZZY SYSTEMS PRESENTLY AT WORK [6]

Industrial	<ol style="list-style-type: none"> 1) Cement kiln Control (Denmark) 2) Automatic train operation (Japan) 3) Water treatment system (Fuji electric, Japan) 4) Water treatment system (Fuji electric, Japan) 5) Smart sensors (Fisher Rosemount, USA) 6) Blast furnace control (NKK Fukoyama, Japan) 7) Nuclear reactor control (Art Fugen, Japan) 8) Fire detector (Cerberus, Switzerland) 9) Camera tracking (NASA, USA) 10) Target tracker in Patriot missile (MMES, USA)
Commercial	<ol style="list-style-type: none"> 1) Washing machine (Matsushita, Japan) 2) Home heating system and air conditions 3) Photocopy machine (Sanyo, Japan) 4) Fuzzy auto focus still camera (Japan) 5) Vacuum cleaner (Sony, Hitachi, Sanyo, Toshiba, Sony) 6) Refrigerator (Sharp) 7) Rice Cooker (Matsushita, Sanyo, Sharp, Hitachi) 8) Home air conditioner (Mitsubishi Heavy Industries, Japan) 9) Fuzzy PLC (Klockner-Moeller, Germany) 10) Fuzzy auto focus still camera (Sanyo, Japan) 11) Smart sensors (Fisher-Rosemount, USA) 12) Health management (OMRON, Japan-USA)
Research	<ol style="list-style-type: none"> 1) Speech recognizer (NTT communication, Japan) 2) Fuzzy medical expert system 3) Helicopter control (LIFE, Japan) 4) Fingerprint classification (NIST, USA) 5) Autonomous robot control (SRI International, USA) 6) Autonomous navigation of robots (ORNL, USA) 7) Used car selection (A used car center in Kansai, Japan)

3) In Tsukamoto model premise is fuzzy set and consequent is also fuzzy set but it monotonically increasing/decreasing membership function and one side is open.

2) Bisector of area (BOA)

3) Mean of maximum (MOM)

4) Smallest of maximum (SOM)

5) Largest of maximum (LOM)

2.4 DEFUZZIFICATION

Defuzzification is the reverse process of Fuzzification. It converts the fuzzy output of the inference engine to crisp using membership functions analogous to the ones used by the fuzzifier. There are five commonly used defuzzifying methods:

1) Centroid of area (COA)

3 APPLICATION OF FUZZY LOGIC

Fuzzy logic is widely used in various field with its successful application. In the early stages, the applications of Fuzzy Logic were confined to control systems and process control where the mathematical

model of the plant is unknown, complex and not well defined. But later, the areas where Fuzzy Control has been applied comprise a wide variety of applications, with different complexity and performances. Washing machines, automatic focusing for video cameras, automatic TV tuner, servo motor control, automotive anti-skid brake and many other consumer appliances use the concept of fuzzy controllers. At present, the application of Fuzzy Logic exceeds the control domain since it is also employed for other knowledge-based decision-making tasks. It involves medical diagnosis, business forecasting, traffic control, network management, Image processing, signal processing, computer vision, geology and many more.

4 ADVANTAGE OF FUZZY LOGIC

The fuzzy control algorithm is based on the operator's experience and field tests. The essence of fuzzy control algorithms is a conditional statement between a fuzzy input variable and a fuzzy output variable. The benefits of fuzzy controllers could be summarized as follows:

- Fuzzy controllers are more robust than PID controllers because they can operate with noise and disturbances of different nature.
- Developing a fuzzy controller is cheaper than developing a model-based controller.
- Fuzzy controllers are customizable, since it is easier to understand and modify their rule, which not only use a human operator's strategy, but also are expressed in natural linguistic terms.
- It is easy to learn how fuzzy controllers operate and how to design and apply them to a concrete application.

It is also important to note that a fuzzy logic can be interfaced with a conventional control[7].

5 SUMMARY

Fuzzy Logic provides a different way to approach a control or classification problem. This method focuses on what the system should do rather than trying to model how it works. One can concentrate on solving the problem rather than trying to model the system mathematically, if that is even possible. On the other hand, the fuzzy approach requires a sufficient expert knowledge for the formulation of the rule base, the combination of the sets and the defuzzification. In General, the employment of fuzzy logic might be helpful, for very complex processes, when there is no simple mathematical model (e.g. Inversion problems), for highly nonlinear processes or if the processing of (linguistically formulated) expert knowledge is to be performed.

REFERENCES:

- [1] L. a. Zadeh, "Fuzzy sets," *Inf. Control*, vol. 8, no. 3, pp. 338-353, 1965.
- [2] S. Haack, "Do we need 'fuzzy logic'?", *eBook-Neutrosophics6.pdf* *International J. Man-Machine Stud.*, vol. 11, no. 4, pp. 437-445, 1979.
- [3] F. Smarandache, "Florentin Smarandache A Unifying Field In Logics : Neutrosophic Logic . Neutrosophy , Neutrosophic Set , Neutrosophic Probability And Statistics (Sixth Edition) ," 2007.
- [4] E. H. Mamdani, "Application of fuzzy algorithms for control of simple dynamic plant," *Proc. Inst. Electr. Eng.*, vol. 121, no. 12, p. 1585, 1974.
- [5] J. Yen, "Fuzzy logic-a modern perspective," *IEEE Trans. Knowl. Data Eng.*, vol. 11, no. 1, pp. 153-165, 1999.
- [6] S. B. Menon, "Review of literature," pp. 36-64, 2012.
- [7] Y. Misra, "A REVIEW ON APPLICATION OF FUZZY LOGIC IN INCREASING THE EFFICIENCY," vol. 1, no. 3, pp. 109-113, 2012.

Alumnae Speaks



*Kelam Sudheer
(M.Tech 2016-18)*

Studying Master's degree is not about learning new theory or doing some great research work but learning how to learn and to identify the chances to apply the things we have learnt before. For me it's been a wonderful experience to be a part of our magazine. The motivation, guidance and support from our professors have given us unlimited opportunity to explore our own skills and knowledge which helped in shaping our future.



*Ankita Benjamin
(M.Tech 2016-18)*

As Bill Cosby has rightly said "there is a time and place for everything, and it's called college". I had a blissful time and I proudly Cherish each moment of it. Our college offered me a challenging yet equally fruitful abode, and I will be forever grateful to the guidance and opportunities provided to us, as it helped me significantly to shape my career.

Alumnae Speaks



*Atul Kumar Tiwari
(M.Tech 2014-16)*

The best thing about the IIITDM is it provides very supportive environment for research. During research many times I used to feel discouraged but my guide Dr. S.K.Jain and other power and control member always helped me to come out of that negative zone and move forward. Power and control lab provide very facility to carry one's research.



*Vinay Kumar Singh
(M.Tech 2016-18)*

IIITDMJ has given me a lot of memories to cherish forever, this is the only place which gave a positive turn to my career. I am very thankful for the motivation and guidance I have got from the faculty members Dr. S.K.Jain sir and Dr. P.K.Padhy sir, both of them have been very supportive & encouraging which leads to very conducive environment for research.

Alumnae Speaks



*Ankita Sharma
(M.Tech 2015-17)*

Power and control system specialization offers MTech and PhD to highly motivated students based on GATE score. The power and control lab is fully AC, well equipped with required experimental setup, two tank control system, and softwares. Good faculties having PhD from IITs with great knowledge in the field of research and publications. Quality interaction among MTech students and PhD scholars. Great emphasis on research and learning new technology. 24hr Wi-Fi facility.



*Deepi Singh
(M.Tech 2015-17)*

This intensive two-year program of MTech was not just a place to learn state-of-the-art academic knowledge from high quality professors, it was also a laboratory to develop new research competencies through active interactions with my lab mates. Opportunities such as projects, lab work, seminars and much more were all stimulating experiments for me. I wish all future students enjoy their new endeavour to awake unlimited potential at power and control lab.

Editorial Board

Editors

Dr. Prabin Kumar Padhy

Associate Professor

Department of Electronics & Communication Engineering

*PDPM Indian Institute of Information Technology, Design & Manufacturing
Jabalpur-482005*

email: prabin16@iiitdmj.ac.in

Dr. Sachin Kumar Jain

Assistant Professor

Department of Electronics & Communication Engineering

*PDPM Indian Institute of Information Technology, Design & Manufacturing
Jabalpur-482005*

email: skjain@iiitdmj.ac.in

Associate Editors

Abhishek Sharma

PhD Student

Department of Electronics & Communication Engineering

*PDPM Indian Institute of Information Technology, Design & Manufacturing
Jabalpur-482005*

email: 1812601@iiitdmj.ac.in

Bharat Verma

Research Scholar

Department of Electronics & Communication Engineering

*PDPM Indian Institute of Information Technology, Design & Manufacturing
Jabalpur-482005*

email: bharatverma@iiitdmj.ac.in

Rishika Trivedi

Research Scholar

Department of Electronics & Communication Engineering

PDPM Indian Institute of Information Technology, Design & Manufacturing

Jabalpur-482005

email: rishika.t@iiitdmj.ac.in

Editorial Office:

Ashish Choubey

Research Scholar

Department of Electronics & Communication Engineering

*PDPM Indian Institute of Information Technology, Design & Manufacturing
Jabalpur-482005*

email: 1812801@iiitdmj.ac.in

Neeraj Goswami

Research Scholar

Department of Electronics & Communication Engineering

*PDPM Indian Institute of Information Technology, Design & Manufacturing
Jabalpur-482005*

email: neeraj.goswami@iiitdmj.ac.in

Preeti Jain

Research Scholar

Department of Electronics & Communication Engineering

*PDPM Indian Institute of Information Technology, Design & Manufacturing
Jabalpur-482005*

email: pjain@iiitdmj.ac.in

Sudeep Sharma

Research Scholar

Department of Electronics & Communication Engineering

*PDPM Indian Institute of Information Technology, Design & Manufacturing
Jabalpur-482005*

email: 1612702@iiitdmj.ac.in

Advisory Council

Prof. Aparajita Ojha

*Department of Computer Science & Engineering
PDPM Indian Institute of Information Technology,
Design & Manufacturing
Jabalpur-482005
email: aojha@iiitdmj.ac.in*

Dr. Anil Kumar

*Assistant Professor
Department of Electronics & Communication
Engineering
PDPM Indian Institute of Information Technology,
Design & Manufacturing
Jabalpur-482005
email: anilk@iiitdmj.ac.in*

Dr. Dinesh Kumar Vishwakarma

*Associate Professor
Department of Electronics & Communication
Engineering
PDPM Indian Institute of Information Technology,
Design & Manufacturing
Jabalpur-482005
email: dineshk@iiitdmj.ac.in*

Prof. P. N. Kondekar

*Department of Electronics & Communication
Engineering
PDPM Indian Institute of Information Technology,
Design & Manufacturing
Jabalpur-482005
email: pnkondekar@iiitdmj.ac.in*

Prof. Puneet Tandon

*Department of Mechanical Engineering & Design
PDPM Indian Institute of Information Technology,
Design & Manufacturing
Jabalpur-482005
email: ptandon@iiitdmj.ac.in*

Prof. V. K. Gupta

*Department of Mechanical Engineering
PDPM Indian Institute of Information Technology,
Design & Manufacturing
Jabalpur-482005
email: vk Gupta@iiitdmj.ac.in*

Design Team

Logo Design

Shubham Bharti

*Design Discipline
PDPM Indian Institute of Information Technology,
Design & Manufacturing
Jabalpur-482005
email: 1610426@iiitdmj.ac.in*

Cover and Article style

Bharat Verma

*Research Scholar
Department of Electronics & Communication
Engineering
PDPM Indian Institute of Information Technology,
Design & Manufacturing
Jabalpur-482005
email: bharatverma@iiitdmj.ac.in*

Table of Content

Abhishek Sharma

*PhD Student
Department of Electronics & Communication
Engineering
PDPM Indian Institute of Information Technology,
Design & Manufacturing
Jabalpur-482005
email: 1812601@iiitdmj.ac.in*

Web design and Content drafting

Sudeep Sharma

*Research Scholar
Department of Electronics & Communication
Engineering
PDPM Indian Institute of Information Technology,
Design & Manufacturing
Jabalpur-482005
email: 1612702@iiitdmj.ac.in*

Rishika Trivedi

*Research Scholar
Department of Electronics & Communication
Engineering
PDPM Indian Institute of Information Technology,
Design & Manufacturing
Jabalpur-482005
email: rishika.t@iiitdmj.ac.in*

From the Secretaries of Associate Editors

Bharat Verma
Rishika Trivedi
Abhishek Sharma
ECE Department, PDPM IITDMJ



The basic motive of the magazine is to impart the learnings of the passing out batches to the upcoming ones. It provides a terrain to create problem statements suitable for carrying out research in the respective fields. Review of different research topics has been willingly presented in this magazine.

Going back to the times when the idea of PacMag cropped up in our mind, we express our sincere gratitude to our Editors without whose constant support and motivation, publication of this magazine wouldn't have been possible. Joining hands in hands we walked together working for this magazine and the journey has been stupendous.

Associate Editors



